

US00D863702S

(12) **United States Design Patent** (10) **Patent No.:** **US D863,702 S**
Wordie et al. (45) **Date of Patent:** **** Oct. 15, 2019**

(54) **VACUUM CLEANER TOOL**
(71) Applicant: **Dyson Technology Limited**, Wiltshire (GB)
(72) Inventors: **Timothy Ewan Ross Wordie**, Bristol (GB); **Alexander John Canning**, Swindon (GB)
(73) Assignee: **Dyson Technology Limited**, Malmesbury, Wiltshire (GB)
(**) Term: **15 Years**
(21) Appl. No.: **29/650,837**
(22) Filed: **Jun. 11, 2018**

(30) **Foreign Application Priority Data**
Dec. 12, 2017 (EM) 004544427-0001
(51) **LOC (12) Cl.** **15-05**
(52) **U.S. Cl.**
USPC **D32/31**
(58) **Field of Classification Search**
USPC D32/17, 18, 22, 31-33
CPC ... A47L 5/24; A47L 5/362; A47L 5/36; A47L 5/28; A47L 9/102; A47L 9/1683; B01D 50/002
See application file for complete search history.

(56) **References Cited**
U.S. PATENT DOCUMENTS
D147,125 S * 7/1947 Harvuot 15/415.1
D158,774 S * 5/1950 Lippincott 15/415.1
D303,026 S * 8/1989 Kilakis D32/32
D375,822 S * 11/1996 Lessig, III D32/15
D405,570 S * 2/1999 Broecking D32/32

6,003,199 A * 12/1999 Shaffer A47L 5/14 15/405
D509,332 S * 9/2005 White D32/32
D513,101 S * 12/2005 Allard D32/32
D526,102 S * 8/2006 Adams D32/32
D652,188 S * 1/2012 Escobar D32/32
D658,832 S * 5/2012 Eden D32/32
D659,923 S * 5/2012 Dyson D32/33
D666,373 S * 8/2012 Eden D32/32
8,533,907 B2 * 9/2013 Eccardt A47L 9/02 138/122
D714,005 S * 9/2014 McGurk D32/32
D733,376 S * 6/2015 Bennett D32/32
D742,085 S * 10/2015 Bennett D32/33
D764,125 S * 8/2016 Palladino D32/33
D796,135 S * 8/2017 Yoon D32/32
D809,230 S * 1/2018 Bowen D32/31

* cited by examiner
Primary Examiner — Ruth McInroy
(74) *Attorney, Agent, or Firm* — Morrison & Foerster LLP

(57) **CLAIM**
We claim the ornamental design for a vacuum cleaner tool, as shown and described.

DESCRIPTION
FIG. 1 is a top perspective view of a vacuum cleaner tool showing our new design;
FIG. 2 is a rear view thereof;
FIG. 3 is a front view thereof;
FIG. 4 is a side view thereof;
FIG. 5 is a side view of the opposite side of FIG. 4;
FIG. 6 is a top view thereof; and,
FIG. 7 is a bottom view thereof.
The broken lines shown in the drawings illustrate portions of a vacuum cleaner tool that form no part of the claimed design.

1 Claim, 4 Drawing Sheets

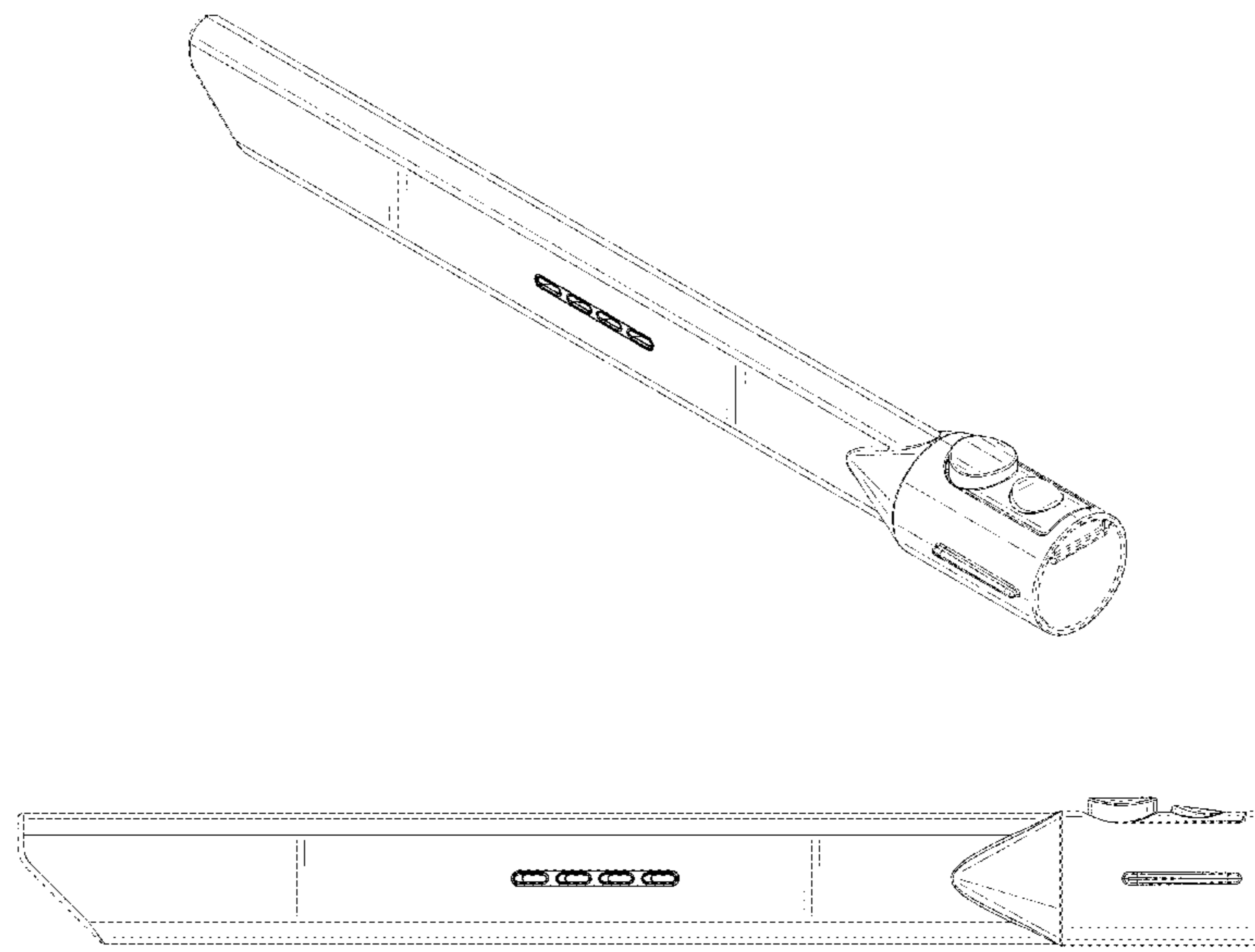

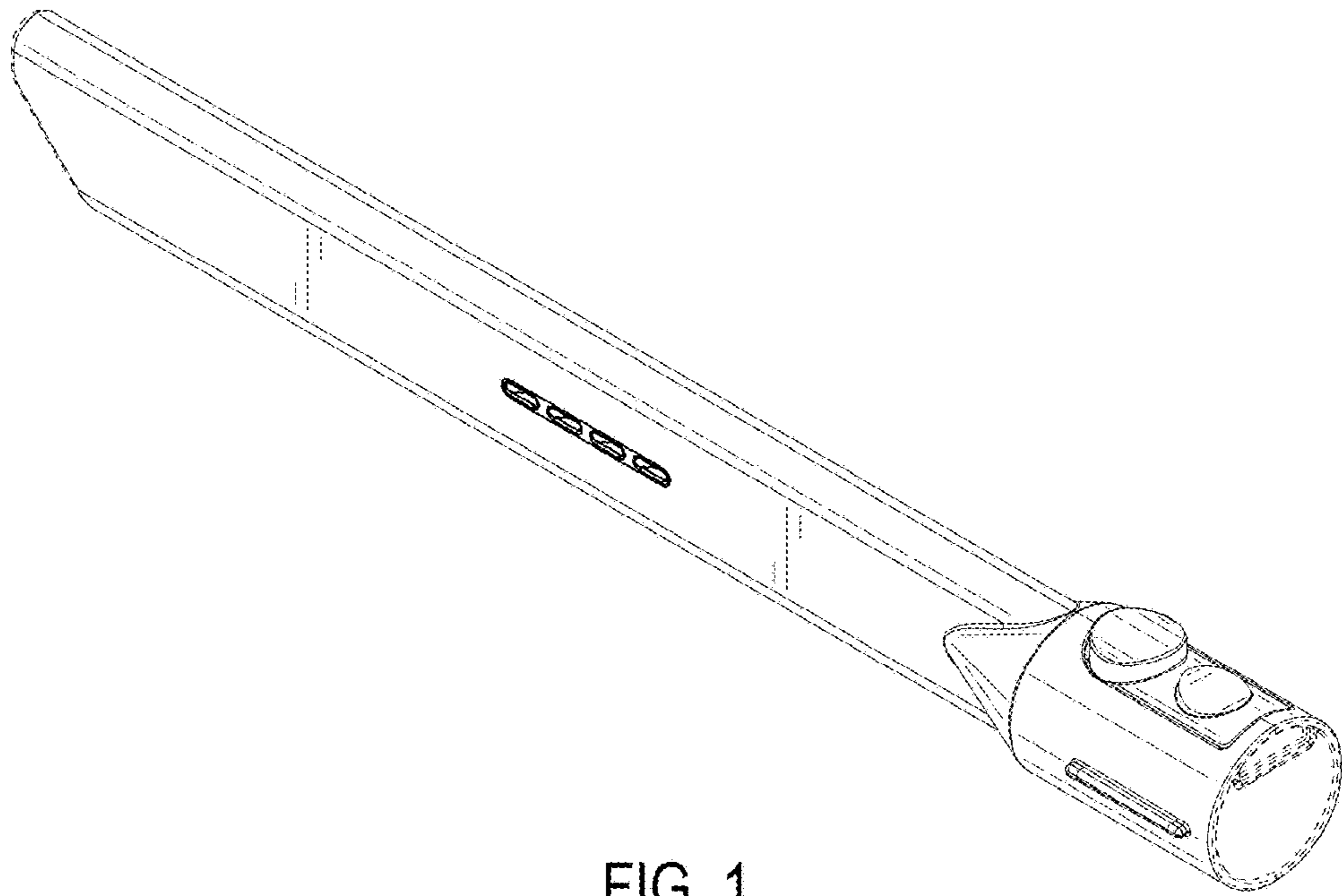

FIG. 1

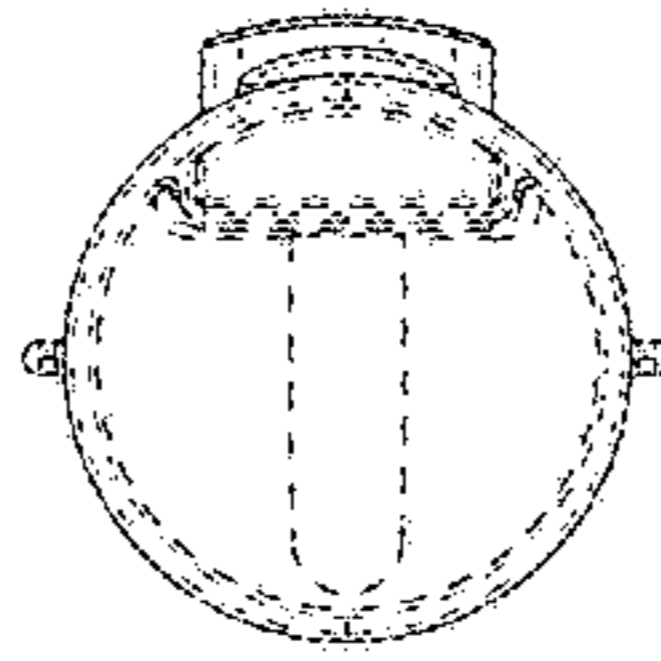

FIG. 2

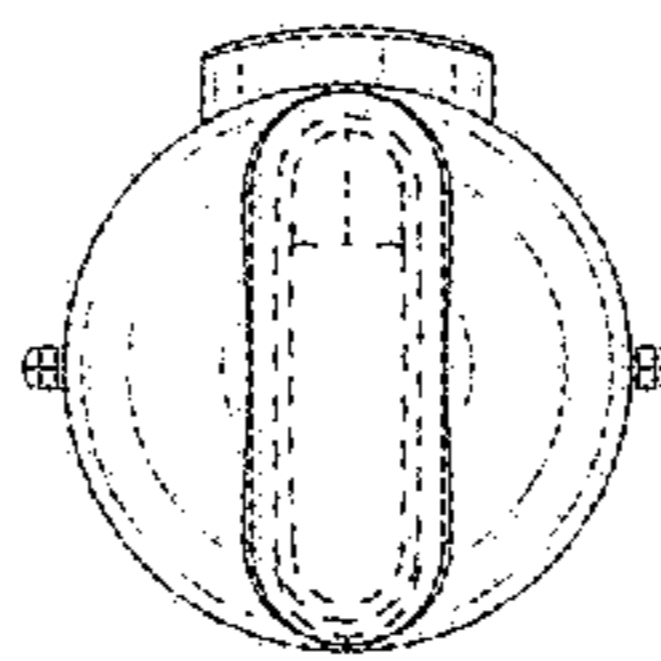

FIG. 3

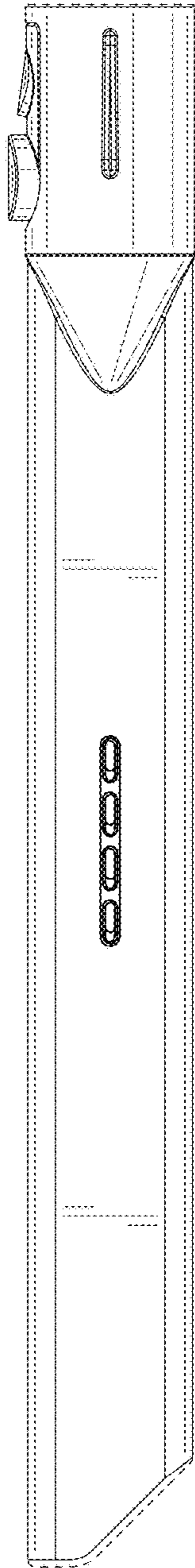

FIG. 4

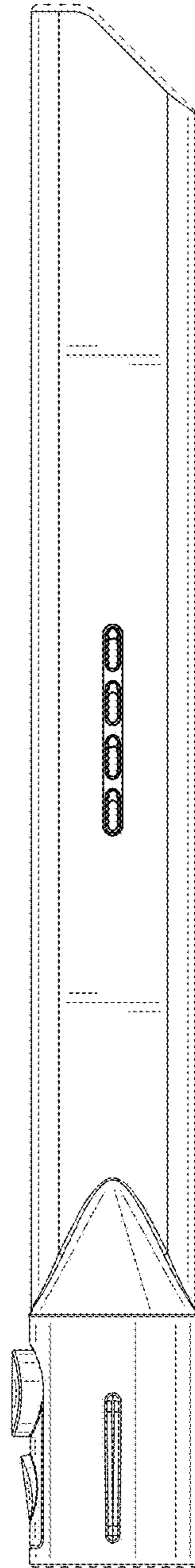

FIG. 5

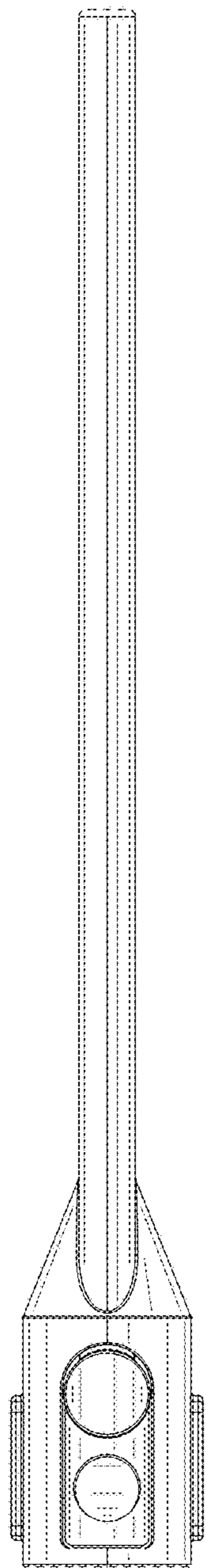

FIG. 6

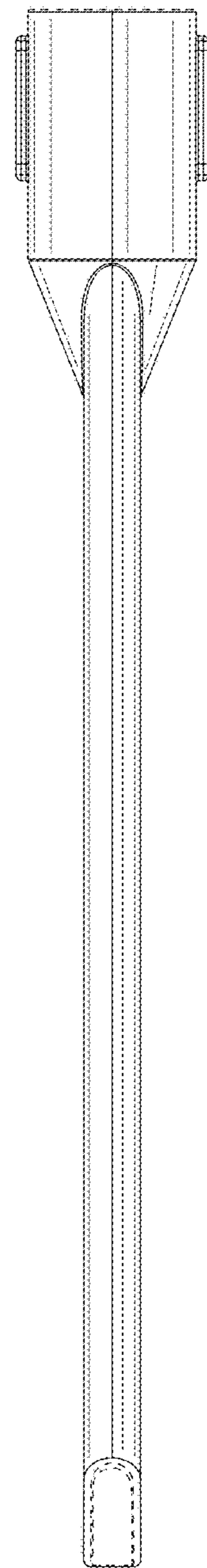

FIG. 7