



US00D863703S

(12) **United States Design Patent**
Wang

(10) **Patent No.:** **US D863,703 S**

(45) **Date of Patent:** **** Oct. 15, 2019**

(54) **ACCESSORY HOLDER FOR VACUUM CLEANER**

(71) Applicant: **Hao Wang**, Guangzhou (CN)

(72) Inventor: **Hao Wang**, Guangzhou (CN)

(**) Term: **15 Years**

(21) Appl. No.: **29/697,164**

(22) Filed: **Jul. 4, 2019**

(51) **LOC (12) Cl.** **15-05**

(52) **U.S. Cl.**
USPC **D32/31**

(58) **Field of Classification Search**
USPC D32/31, 25; D6/553, 569, 570; 15/323
CPC A47L 9/00; A47L 9/0018; A47L 9/0027;
A47L 9/0036; A47L 9/0045
See application file for complete search history.

(56) **References Cited**

U.S. PATENT DOCUMENTS

- 3,872,538 A * 3/1975 Crouser A47L 9/0027
15/323
- D272,572 S * 2/1984 Parise D32/31
- D294,755 S * 3/1988 Lackner D32/31
- D295,334 S * 4/1988 Fonville D32/31
- D295,910 S * 5/1988 Hill D32/31
- D308,267 S * 5/1990 Bradd D13/108
- 5,071,012 A * 12/1991 Jailor A47L 9/0009
15/323
- D329,511 S * 9/1992 McKnight D32/25
- D354,380 S * 1/1995 Stephens D32/31
- D357,562 S * 4/1995 Chumley D32/31
- D363,163 S * 10/1995 Funatsu D3/315
- 5,528,794 A * 6/1996 Tomasiak A47L 9/0009
15/323
- D374,523 S * 10/1996 Tomasiak D32/31
- D391,703 S * 3/1998 Miller D32/22
- 5,943,731 A * 8/1999 Wood A47L 9/0018
15/323
- 5,954,863 A * 9/1999 Loveless A47L 5/365
15/353

- D422,764 S * 4/2000 Wood D32/31
- 6,058,558 A * 5/2000 Kim A47L 9/0045
15/323
- D434,886 S * 12/2000 Wareham D32/31
- D435,152 S * 12/2000 Stephens D32/31
- D444,603 S 7/2001 Murphy et al.
- D447,609 S * 9/2001 Hult D32/31

(Continued)

OTHER PUBLICATIONS

LANMU Docks Station Accessory Holder for Dyson V6 Vacuum. Retrieved from Internet: www.amazon.com/LANMU-Station-Accessory-Attachments-Organizer/dp/B07TP5GDHC/ref=sr_1_17_sspa?keywords=dyson+vacuum+cleaner+tool+holder&qid=1565283128&s=gateway&sr=8-17-spons&psc=1. Retrieved on Aug. 8, 2019. (Year: 1996).*

(Continued)

Primary Examiner — Ruth McInroy
(74) *Attorney, Agent, or Firm* — KA Filing LLC; Wayne V. Harper

(57) **CLAIM**

I claim the ornamental design for an accessory holder for vacuum cleaner, as shown and described.

DESCRIPTION

FIG. 1 is a perspective view of an accessory holder for vacuum cleaner showing my new design;
FIG. 2 is a left-side view thereof;
FIG. 3 is a right-side view thereof;
FIG. 4 is a top view thereof;
FIG. 5 is a bottom view thereof;
FIG. 6 is a front view thereof;
FIG. 7 is a rear view thereof; and,
FIG. 8 is a front view thereof; shown attached to the vacuum cleaner shown in broken lines which forms no part of the claimed design.

1 Claim, 7 Drawing Sheets

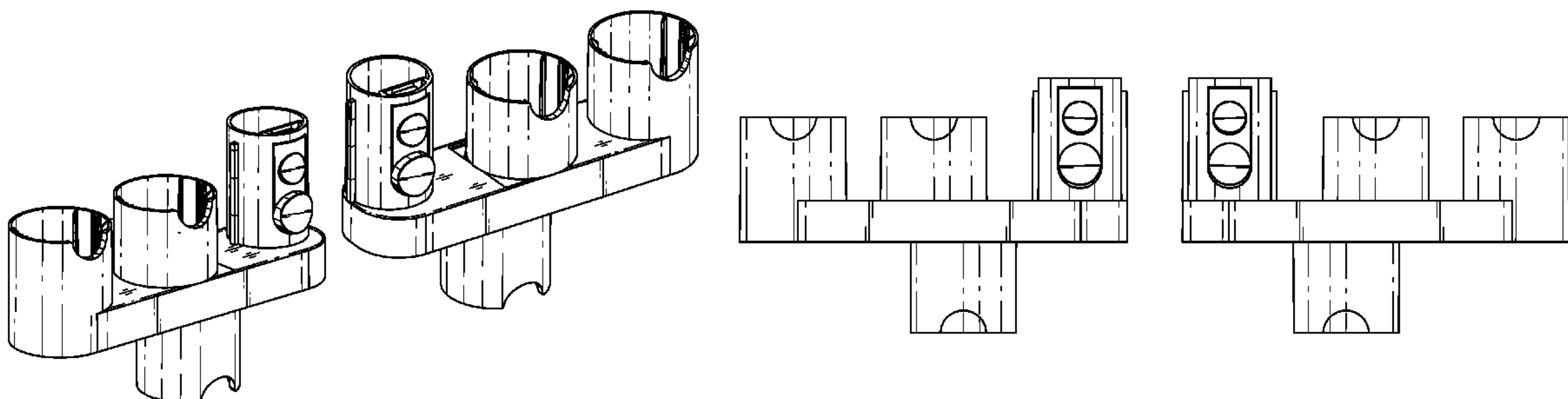

(56)

References Cited

U.S. PATENT DOCUMENTS

6,345,407 B1 * 2/2002 Jupp A47L 9/0009
15/323
D463,079 S * 9/2002 Leyden D32/31
D469,228 S * 1/2003 Wareham D32/31
6,543,085 B2 * 4/2003 Holsten A47L 9/327
15/327.2
D487,536 S 3/2004 Aagren
7,284,297 B2 * 10/2007 Shanor A47L 9/0018
15/246.2
D564,819 S * 3/2008 Fosburg D6/569
D567,560 S * 4/2008 Byers D6/553
D623,367 S * 9/2010 Gottschall D32/31
D657,101 S * 4/2012 Williams D32/23
D666,369 S * 8/2012 Williams D32/23
8,522,394 B2 * 9/2013 Lee A47L 9/0036
15/323
D713,109 S * 9/2014 Seasholtz D32/31
8,826,490 B1 * 9/2014 Giarmo A47L 5/00
15/323
8,955,234 B2 * 2/2015 Williams F26B 23/04
211/85.7
D731,206 S * 6/2015 Beebe D6/553
D731,810 S * 6/2015 Beebe D6/553
9,167,942 B1 * 10/2015 Seasholtz A47L 9/0027
D743,655 S * 11/2015 Holsten D32/31
D762,335 S * 7/2016 Fry D32/31
10,194,779 B2 * 2/2019 Kim A47L 5/225

2002/0138937 A1 * 10/2002 Griffin A47L 9/26
15/323
2003/0024067 A1 * 2/2003 Roney A47L 9/0009
15/323
2004/0098822 A1 * 5/2004 Martinez A47L 5/365
15/323
2004/0188570 A1 * 9/2004 Bauer F16L 3/223
248/68.1

OTHER PUBLICATIONS

LANMU Docks Station Accessory Holder Attachments Organizer Compatible With Dyson V11 V10 V8 V7 Cordless Stick Vacuum Cleaner, Wall Mount Accessories for Dyson Vacuums, https://www.amazon.com/LANMU-Accessory-Attachments-Compatible-Accessories/dp/B07GVJMBZV/ref=cm_cr_arp_d_product_top?ie=UTF8.
LANMU Adapter Converter Set for Dyson V7 V8, Replacement for Dyson Vacuum Cleaner Attachments, Attachment Holder for Dyson V7 V8 Vacuum Cleaner (2 Pack Gray), https://www.amazon.co.uk/dp/B07GZBRVM2?ref=myi_title_dp.
Zubehör Halter Organizer Dockingstation Kompatibel Mit Dyson V11 V10 V8 V7 Staubsauger Zubehörteile Halterung (2 Stück), https://www.amazon.de/dp/B07KF3JFJK?ref=myi_title_dp.
Docks Station Stand Holder for Dyson V11 V10 V8 V7 Cordless Stick Vacuum Cleaner, <https://www.ebay.com/itm/382617673350>.

* cited by examiner

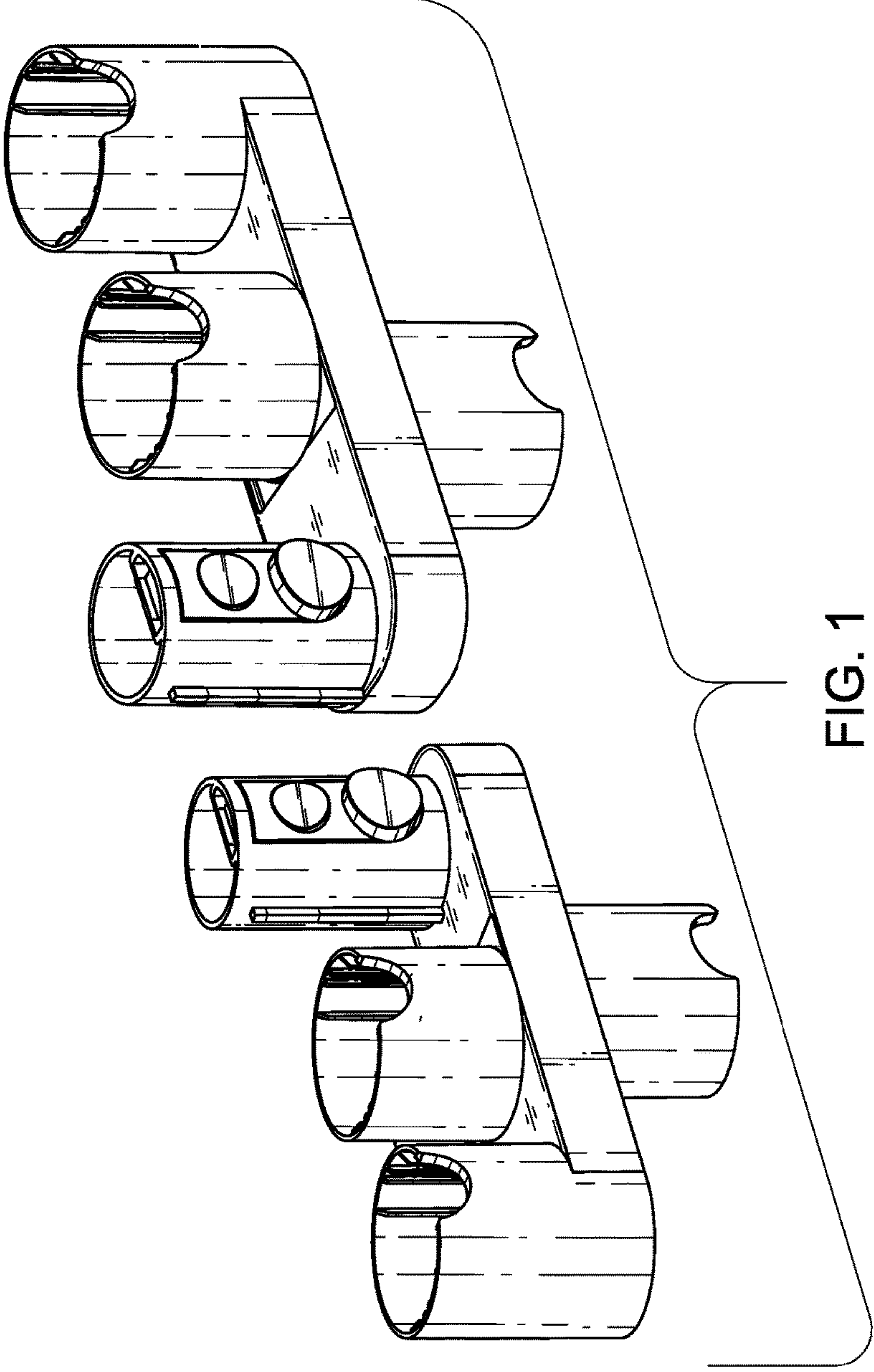

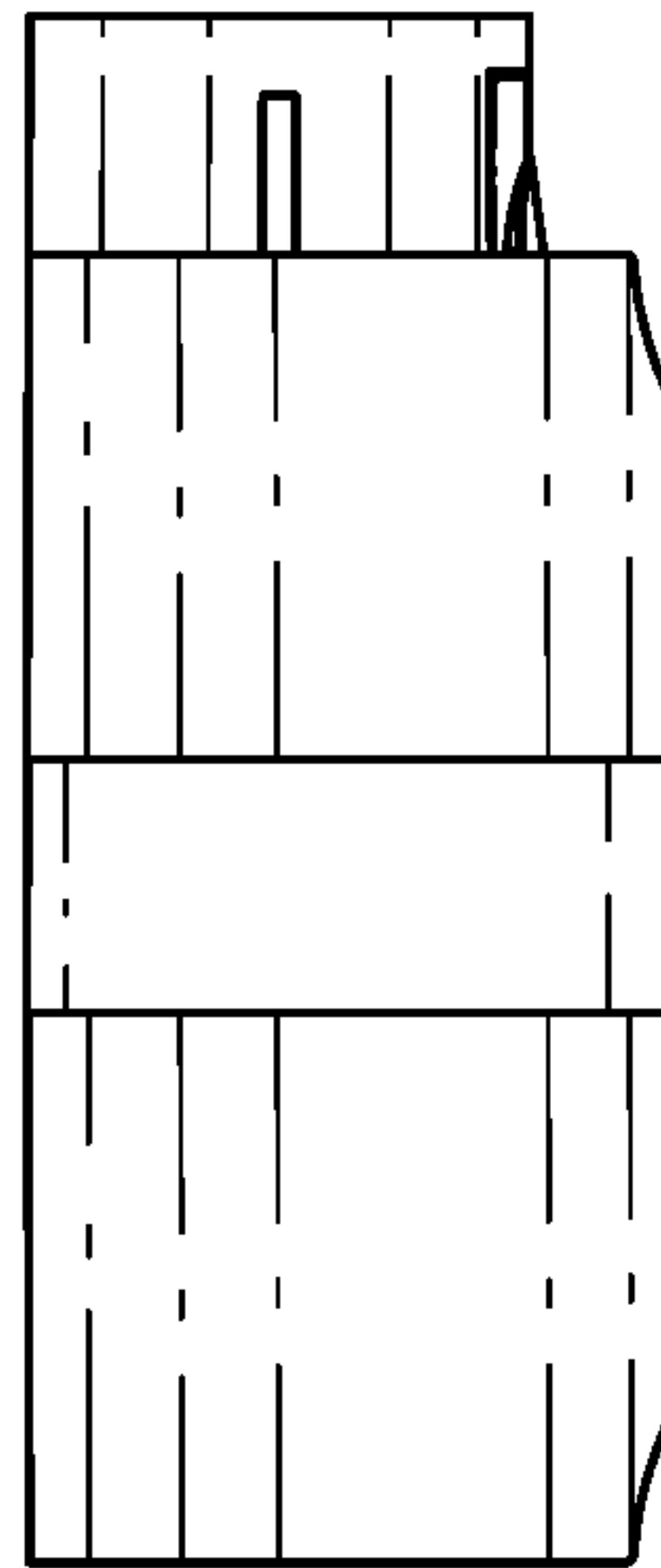

FIG. 2



FIG. 3

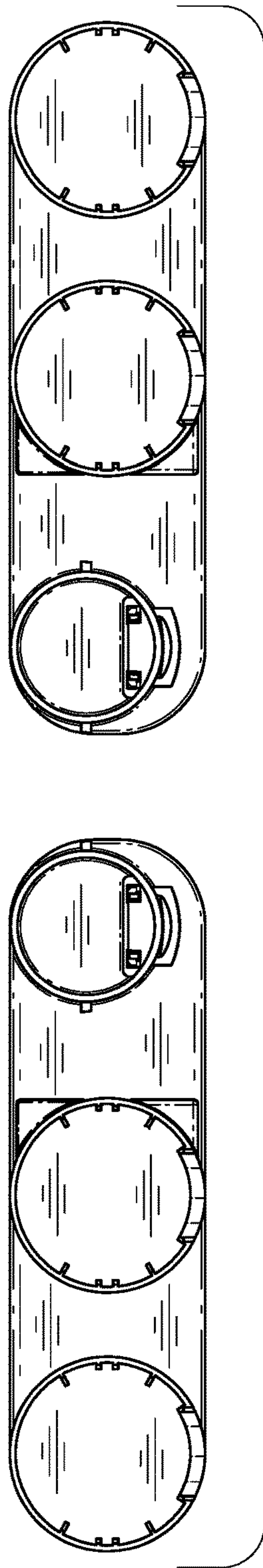

FIG. 4

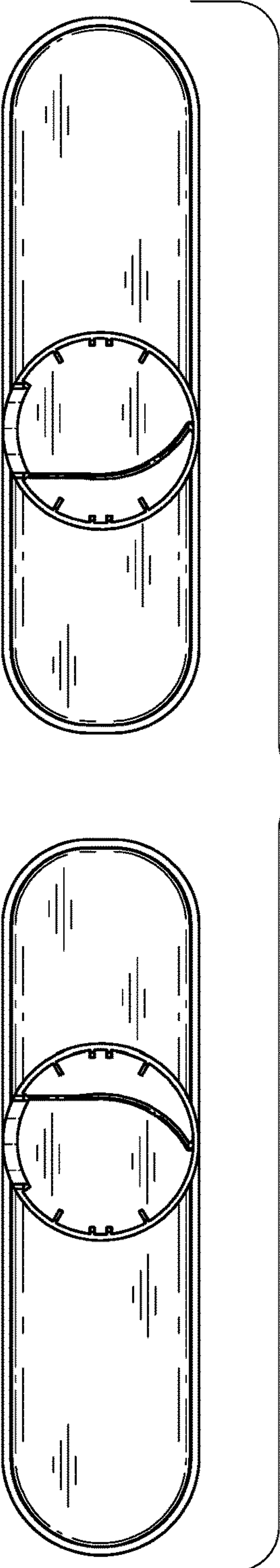

FIG. 5

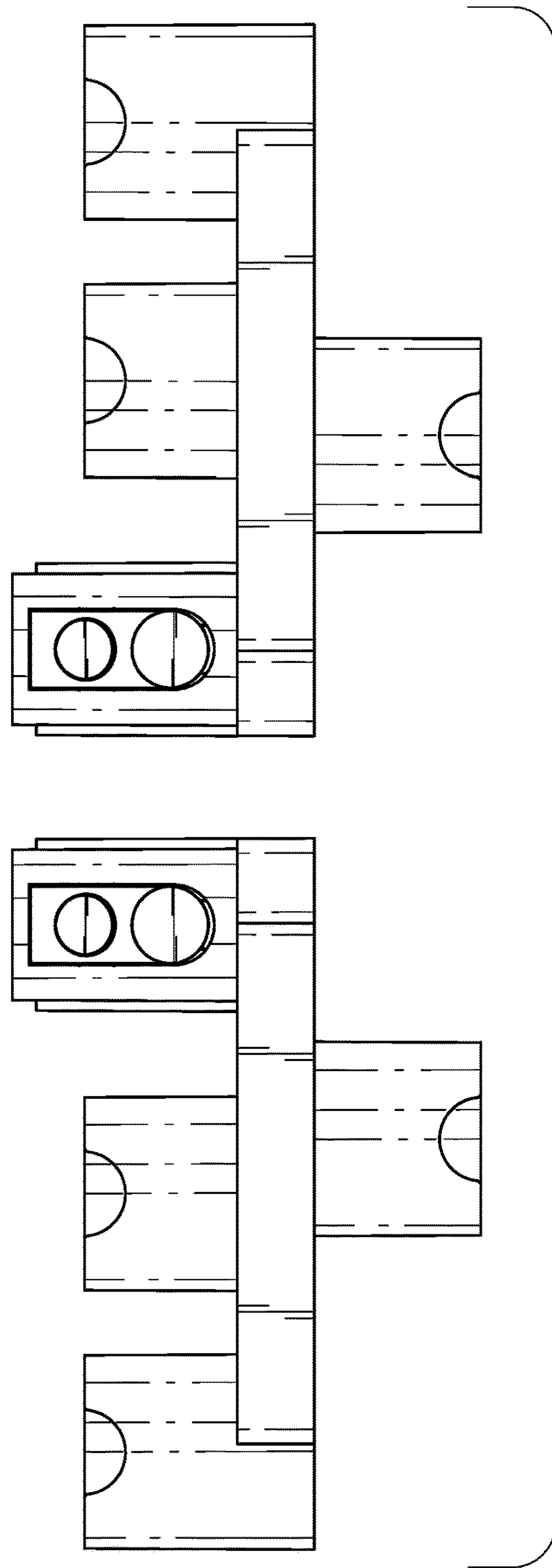

FIG. 6

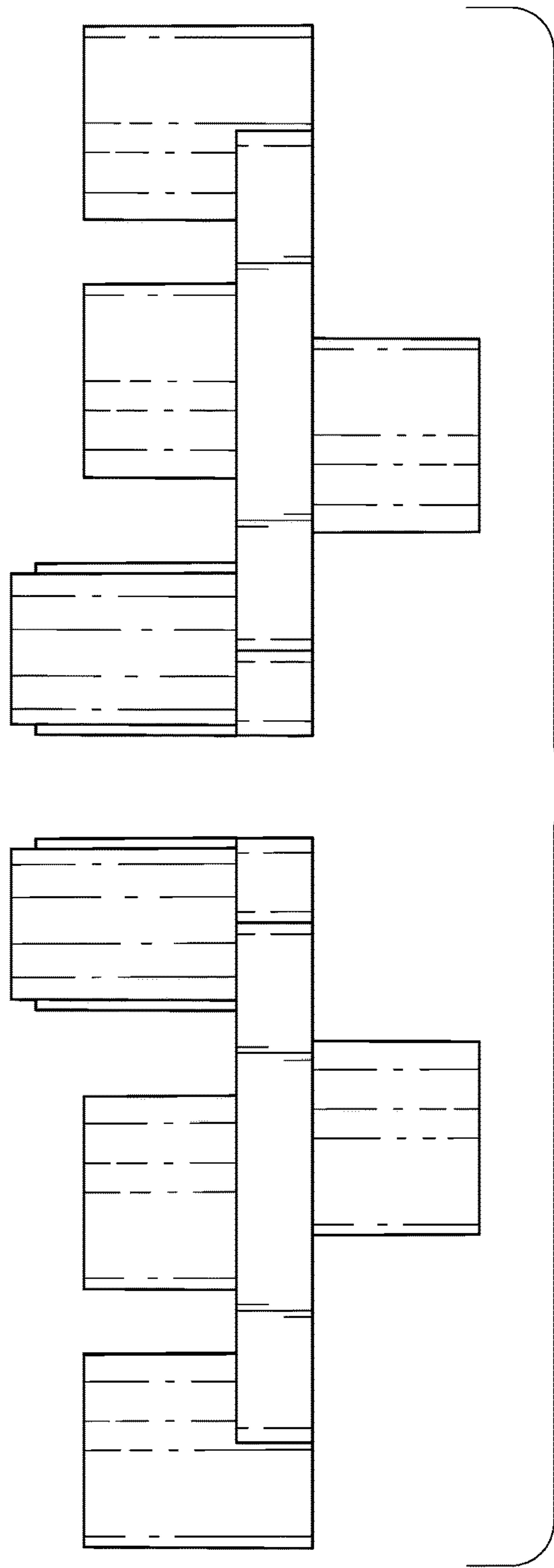

FIG. 7

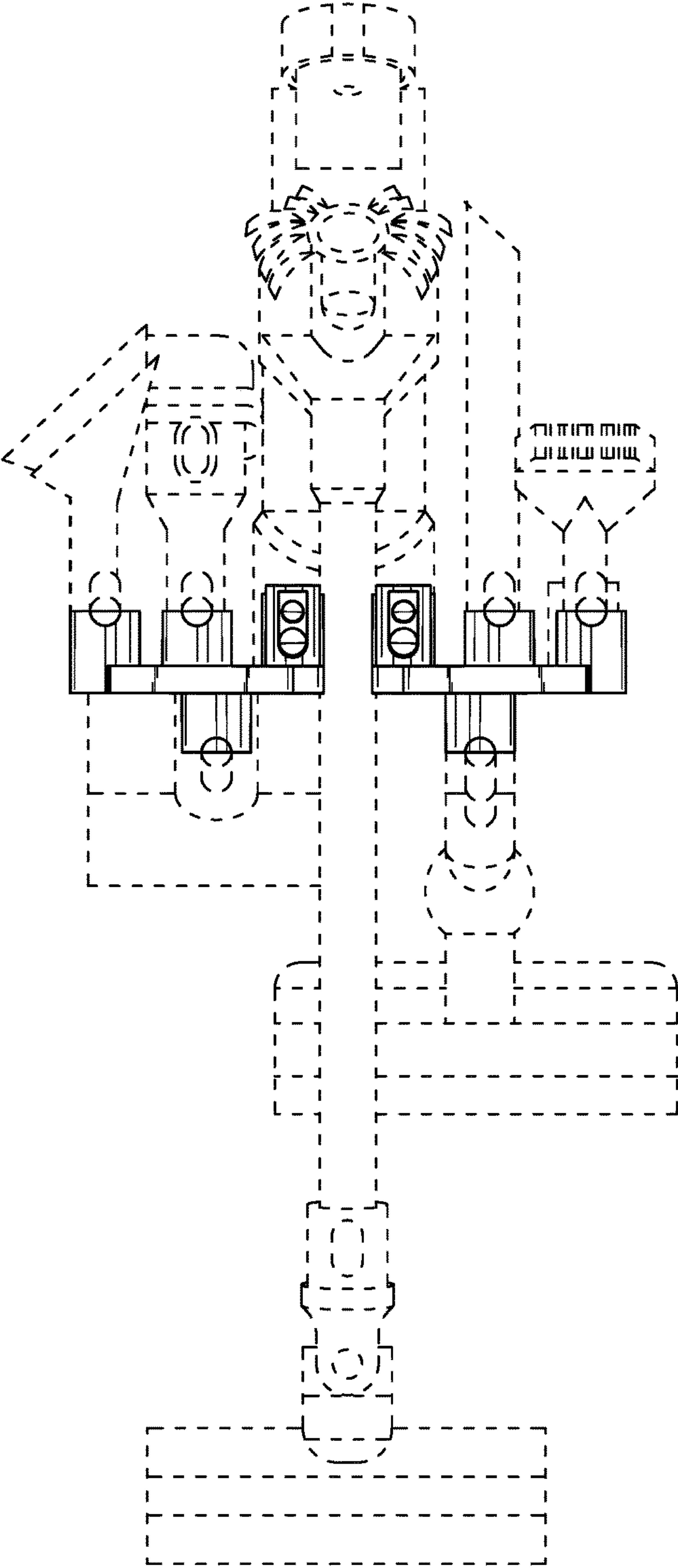

FIG. 8