



US00D863492S

(12) **United States Design Patent**
Mahnke

(10) **Patent No.:** **US D863,492 S**
(45) **Date of Patent:** **** Oct. 15, 2019**

- (54) **PROJECTILE**
- (71) Applicant: **G9 Holdings, LLC**, Lakewood, CO (US)
- (72) Inventor: **Joshua Mahnke**, Arvada, CO (US)
- (73) Assignee: **G9 Holdings, LLC**, Lakewood, CO (US)
- (**) Term: **15 Years**
- (21) Appl. No.: **29/590,952**
- (22) Filed: **Jan. 13, 2017**

Related U.S. Application Data

- (63) Continuation of application No. 14/701,519, filed on Apr. 30, 2015, now Pat. No. 9,709,368.
- (51) **LOC (12) Cl.** **22-03**
- (52) **U.S. Cl.**
USPC **D22/115**
- (58) **Field of Classification Search**
USPC D22/107, 115-116
CPC F41A 9/83; F41A 9/82; F41A 9/01; F41A 9/09; F41A 9/86; F42B 30/02; F42B 5/02; F42B 5/26; F42B 12/34; F42B 8/04; F42B 10/22; F42B 8/14
See application file for complete search history.

References Cited

U.S. PATENT DOCUMENTS

760,338 A	5/1904	Kwiatkowski	
1,596,180 A	8/1926	Henderson	
2,342,006 A	2/1944	Moore	
2,612,108 A	9/1952	Schmidt	
2,941,469 A	6/1960	Barnhart	
3,557,702 A	1/1971	Benson	
3,580,179 A	5/1971	Gawlick et al.	
3,901,158 A	8/1975	Ferb	
3,949,677 A	4/1976	Voss	
D244,448 S *	5/1977	Bonine	D22/115
4,301,733 A	11/1981	Blanco	

4,643,435 A *	2/1987	Musacchia	F42B 6/08 30/303
4,644,866 A	2/1987	Sullivan	
4,700,630 A	10/1987	Sullivan	
4,829,904 A	5/1989	Sullivan	
4,829,906 A	5/1989	Kaswer	
4,867,065 A	9/1989	Kaltmann et al.	
H770 H	4/1990	Kline et al.	
D310,553 S *	9/1990	Kania	D22/115
D314,416 S *	2/1991	Rezmer	D22/115
5,020,438 A	6/1991	Brown	
5,094,464 A *	3/1992	Musacchia, Sr.	A01K 81/04 403/349
5,116,224 A *	5/1992	Kelsey, Jr.	F42B 10/22 102/439
5,133,261 A	7/1992	Kelsey, Jr.	
D343,439 S *	1/1994	Kuczewski	D22/116
D363,335 S *	10/1995	Dixon	D22/116
5,493,975 A *	2/1996	Franzini	B25C 1/163 102/470
5,496,043 A	3/1996	Ester	
5,841,058 A *	11/1998	Manis	F41A 1/02 89/8
5,907,121 A *	5/1999	Fritze	F42B 5/025 102/435
5,932,836 A	8/1999	White	
6,070,532 A *	6/2000	Halverson	F42B 14/02 102/501
D435,886 S *	1/2001	Benini	D22/100
6,182,574 B1	2/2001	Giannoni	
D447,208 S *	8/2001	Benini	D22/116
6,306,053 B1	10/2001	Liechty, II	
6,439,123 B1 *	8/2002	Dionne	F42B 5/02 102/430
6,439,125 B1	8/2002	Carter	
6,581,522 B1	6/2003	Julien et al.	
6,971,315 B2	12/2005	Knappworst et al.	
7,204,191 B2	4/2007	Wiley et al.	
7,207,276 B1 *	4/2007	Dindl	F42B 5/02 102/443
7,213,519 B2	5/2007	Wiley et al.	
D563,100 S	3/2008	Epling et al.	
D566,805 S	4/2008	Earl	
D583,897 S *	12/2008	Ward	D22/107
7,484,459 B2	2/2009	Fichot et al.	
D621,468 S	8/2010	Nilsson	
D625,380 S	10/2010	Walter et al.	
D626,619 S	11/2010	Gogol et al.	
D632,357 S *	2/2011	Dixon	D22/116
D652,472 S	1/2012	Klement	
8,161,885 B1	4/2012	Emary	
8,186,277 B1	5/2012	King	
8,365,672 B2	2/2013	Calero Martinez et al.	

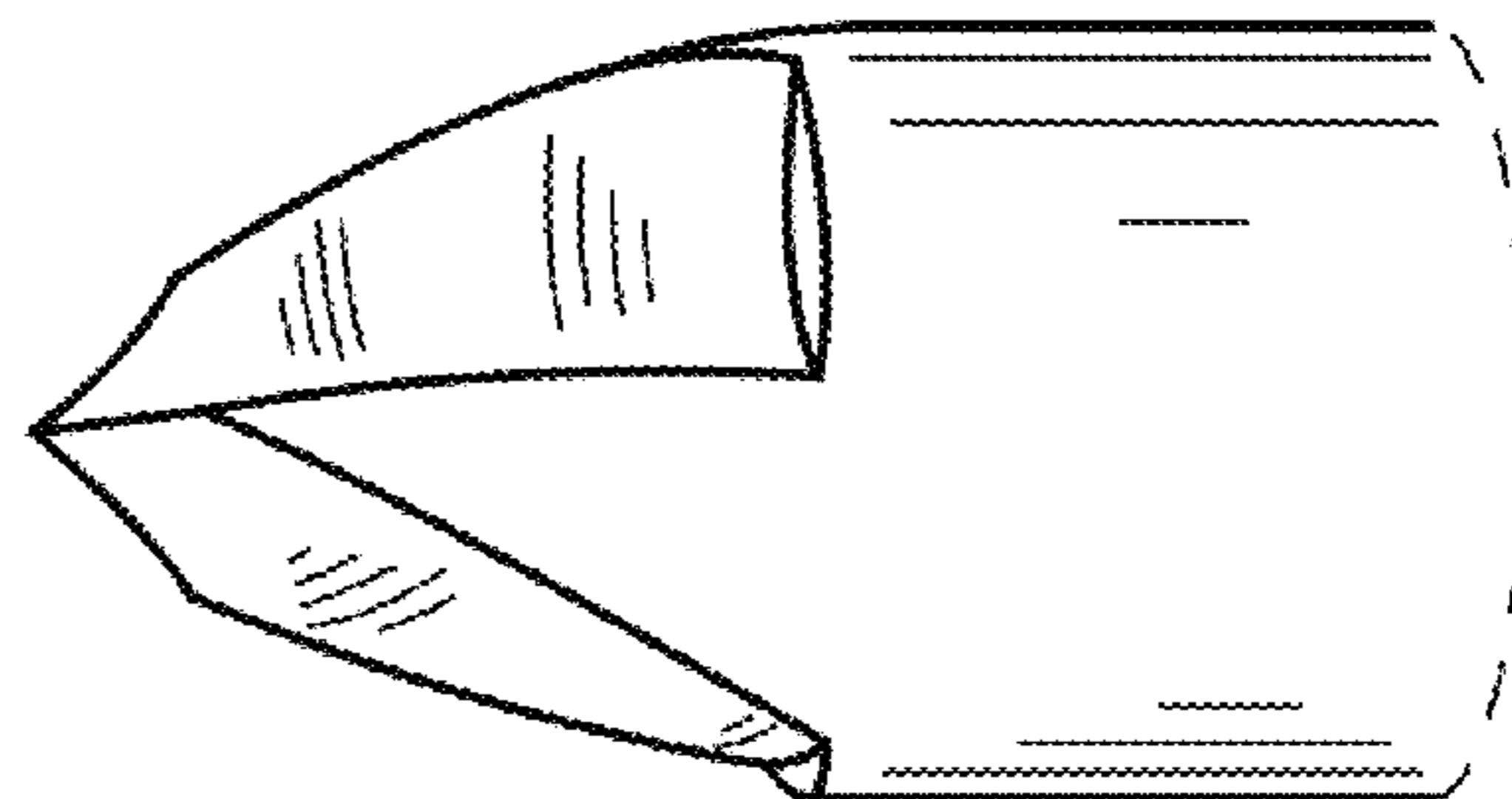
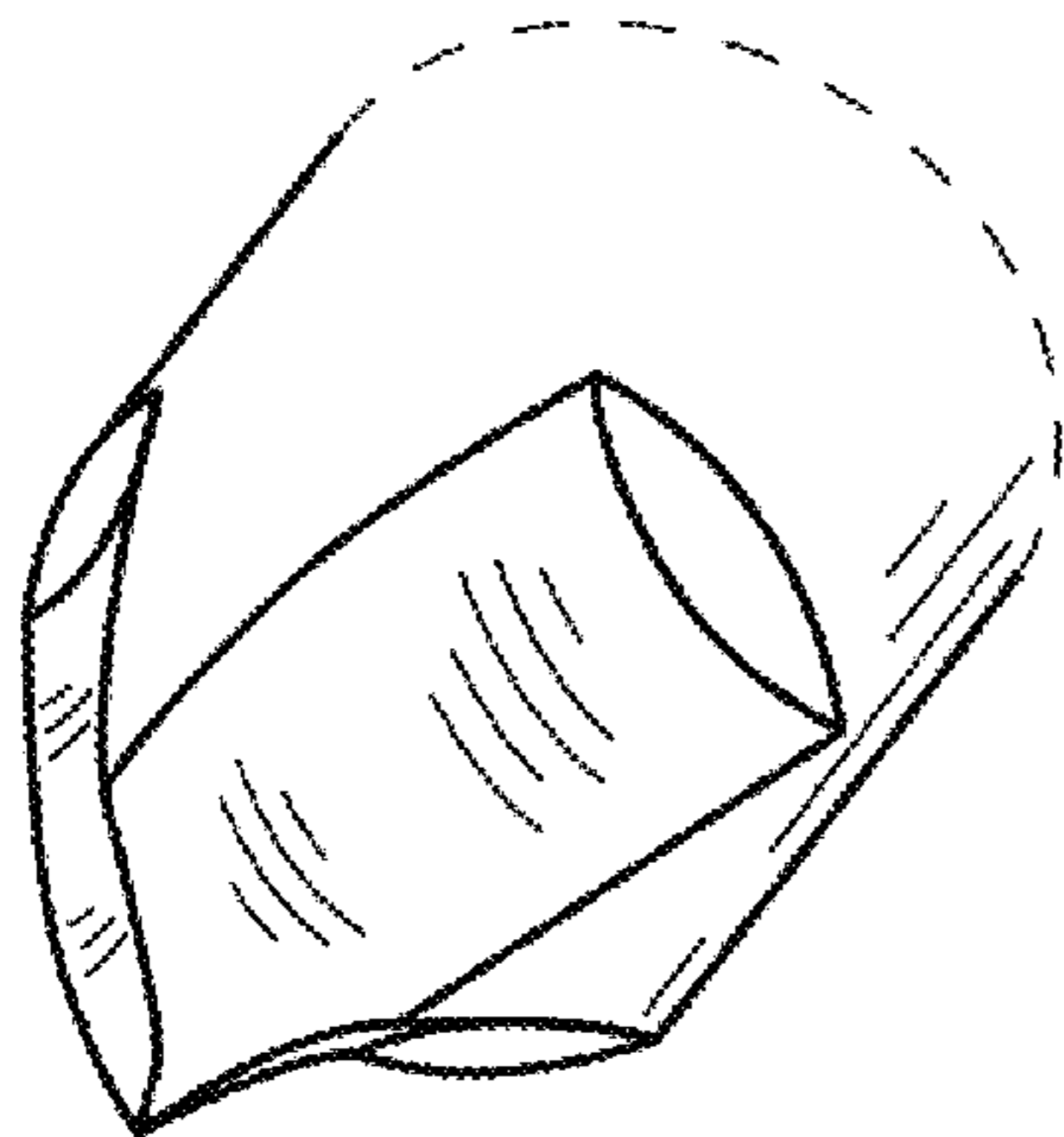

D689,975	S	9/2013	Carlson et al.	
D707,785	S	6/2014	Seecamp	
8,763,535	B2	7/2014	Padgett	
D710,962	S *	8/2014	Pedersen	D22/107
D713,919	S *	9/2014	Rager	D22/107
D717,909	S	11/2014	Thrift et al.	
D722,126	S	2/2015	Bray	
D723,653	S	3/2015	Peterson	
D724,690	S	3/2015	Carson et al.	
D726,281	S	4/2015	Powers, Jr.	
D733,252	S	6/2015	Burczynski et al.	
D733,834	S	7/2015	Burczynski et al.	
D733,835	S	7/2015	Burczynski et al.	
D733,836	S	7/2015	Burczynski et al.	
D733,837	S	7/2015	Burczynski et al.	
D734,419	S	7/2015	Burczynski et al.	
D735,289	S	7/2015	Burczynski et al.	
9,121,677	B2	9/2015	Emary	
D743,500	S *	11/2015	Pedersen	D22/107
D747,781	S	1/2016	Alculumbre	
D748,220	S	1/2016	Fricke	
D750,723	S *	3/2016	Rager	D22/107
D751,166	S	3/2016	Seecamp	
D751,167	S *	3/2016	Chua	D22/116
D752,702	S	3/2016	Arnedo Vera et al.	
D752,703	S	3/2016	Arnedo Vera et al.	
D753,258	S	4/2016	Arnedo Vera et al.	
D754,222	S	4/2016	Pederson et al.	
D754,223	S	4/2016	Pederson et al.	
9,316,468	B2	4/2016	Rall et al.	
D759,189	S	6/2016	Pederson et al.	
D764,624	S	8/2016	Masinelli	
D768,798	S *	10/2016	Loa	D22/107
D768,802	S	10/2016	Bowers	
D770,005	S *	10/2016	Christiansen	D22/116
D775,305	S *	12/2016	Fiocchi	D22/116
D780,876	S *	3/2017	Boatright	D22/116
D781,980	S *	3/2017	Wallace	D22/107
9,863,746	B2	1/2018	Peterson	
D821,536	S *	6/2018	Christiansen	D22/116
2002/0055404	A1	5/2002	Liechty, II	
2005/0005807	A1	1/2005	Wiley et al.	
2005/0241523	A1	11/2005	Schikora et al.	
2006/0027128	A1	2/2006	Hober	
2006/0030438	A1	2/2006	Hajek	
2006/0096491	A1	5/2006	Fichot	
2013/0263754	A1	10/2013	Neme	
2015/0075400	A1	3/2015	Lemke et al.	
2015/0204639	A1	7/2015	Riley	
2015/0268020	A1	9/2015	Emary	
2016/0153757	A1	6/2016	Mahnke	
2016/0231093	A1	8/2016	Lemke et al.	
2017/0314900	A1	11/2017	Mahnke	

FOREIGN PATENT DOCUMENTS

CA	577406	6/1959
EP	0015574	9/1980
EP	0502221	9/1992
EP	2498046	9/2012
GB	451031	7/1936
WO	WO 86/06827	11/1986
WO	WO 99/37971	7/1999
WO	WO 2008/048224	4/2008
WO	WO 2013/096848	6/2013
WO	WO 2015/048102	4/2015

OTHER PUBLICATIONS

U.S. Appl. No. 15/406,781, filed Jan. 16, 2017, Mahnke.
 U.S. Appl. No. 15/407,102, filed Jan. 16, 2017, Mahnke.
 "ELD® Match," Hornady Manufacturing Company, 2016, retrieved from <http://www.hornady.com/store/BELD-Match-New>, 3 pages.
 "ELD-X®," Hornady Manufacturing Company, 2016, retrieved from <http://www.hornady.com/store/ELD-X-New>, 2 pages.
 "Hornady® BLACK™," Hornady Manufacturing Company, 2016, retrieved from <http://www.hornady.com/store/Black-new>, 3 pages.

"Inceptor ARX Product Sheet," PolyCase Ammunition, Jan. 2015, 1 page.
 "Inceptor Preferred Defense," Polycase Ammunition, retrieved from <http://www.polycaseammo.com/project/inceptor-arx>, retrieved on Nov. 2016, 2 pages.
 "Inceptor Preferred Hunting®," Polycase Ammunition, retrieved from <http://www.polycaseammo.com/project/inceptor-preferred-hunting>, retrieved on Nov. 2016, 2 pages.
 "Match™," Hornady Manufacturing Company, 2016, retrieved from <http://www.hornady.com/store/Match-newammo>, 3 pages.
 "Polycase Ammo Shows Off New Ammo at SHOT Show 2014," Matt Alpert, 2014, retrieved from <https://www.youtube.com/watch?v=Y9Pp9gRNqal>, retrieved on May 2, 2016, 1 page (screen shot of YouTube video web page).
 "PolyCase ARX + RNP Product Sheet," PolyCase Ammunition, Jan. 2015, 1 page.
 "Ruger® Ammunition," Sturm, Ruger & Co., Inc., retrieved from <http://www.ruger.com/micros/ammo/index.html?r=y>, retrieved on Nov. 2016, 3 pages.
 ES P201331387 (priority document for WO 2015/048102), filed Sep. 24, 2013, 21 pages, English translation unavailable.
 Horman, "Tested: The Polycase ARX Bullet," American Rifleman, 2015, 6 pages.
 International Search Report and Written Opinion for International (PCT) Patent Application No. PCT/US15/28661, dated Jan. 7, 2016, 11 pages.
 International Preliminary Report on Patentability for International (PCT) Patent Application No. PCT/US15/28661, dated Oct. 12, 2016, 9 pages.
 Official Action for U.S. Appl. No. 14/701,519, dated Apr. 5, 2016, 7 pages, Restriction Requirement.
 Official Action for U.S. Appl. No. 14/701,519, dated Aug. 26, 2016, 9 pages.
 U.S. Appl. No. 29/612,522, filed Aug. 1, 2017, Mahnke.
 Notice of Allowance for U.S. Appl. No. 14/701,519, dated Mar. 24, 2017, 8 pages.
 Extended European Search Report for European Patent Application No. 15819768.1, dated Dec. 1, 2017, 11 pages.
 Restriction Requirement for U.S. Appl. No. 15/406,781, dated Feb. 28, 2018, 7 pages.
 Official Action for Israel Patent Application No. 248588, dated Feb. 7, 2018 7 pages.
 Official Action for U.S. Appl. No. 15/651,997, dated May 14, 2018 7 pages Restriction Requirement.
 Official Action for U.S. Appl. No. 15/406,781, dated Sep. 5, 2018 6 pages Restriction Requirement.
 Official Action for U.S. Appl. No. 15/406,781, dated Feb. 1, 2019 7 pages.
 Official Action for U.S. Appl. No. 29/612,522, dated Mar. 8, 2019 6 pages Restriction Requirement.
 Official Action for U.S. Appl. No. 15/651,997, dated Feb. 14, 2019 11 pages.
 Official Action for Australia Patent Application No. 2015288295, dated Mar. 6, 2019 6 pages.
 Notice of Allowance for Israel Patent Application No. 248588, dated Jun. 16, 2019 3 pages.
 Notice of Allowance for U.S. Appl. No. 15/406,781, dated Jul. 25, 2019 8 pages.
 Notice of Allowance for U.S. Appl. No. 29/612,522, dated Jul. 11, 2019 6 pages.
 Notice of Allowance for U.S. Appl. No. 15/651,997, dated Jul. 29, 2019 8 pages.

* cited by examiner

Primary Examiner — Michael A. Pratt

(74) *Attorney, Agent, or Firm* — Sheridan Ross P.C.

(57) **CLAIM**

The ornamental design for a projectile, as shown and described.

DESCRIPTION

FIG. 1 is a perspective view of the projectile;
 FIG. 2 is a front elevation view thereof;
 FIG. 3 is a rear elevation view thereof;
 FIG. 4 is a top plan view thereof;
 FIG. 5 is a bottom plan view thereof;
 FIG. 6 is a left elevation view thereof;
 FIG. 7 is a right elevation view thereof;
 FIG. 8 is a perspective view of a projectile according to an alternative embodiment;
 FIG. 9 is a rear elevation view of the projectile of FIG. 8;
 FIG. 10 is a front elevation view of the projectile of FIG. 8;
 FIG. 11 is a top plan view of the projectile of FIG. 8;
 FIG. 12 is a bottom plan of the projectile of FIG. 8;
 FIG. 13 is a left elevation view of the projectile of FIG. 8;
 FIG. 14 is a right elevation view of the projectile of FIG. 8;
 FIG. 15 is a perspective view of a projectile according to an alternative embodiment, where the projectile is symmetrical around its longitudinal axis when split into thirds;
 FIG. 16 is a top plan view of the projectile of FIG. 15;
 FIG. 17 is a bottom plan view of the projectile of FIG. 15;
 FIG. 18 is a front elevation view of the projectile of FIG. 15, which is a mirror image of the rear elevation view;
 FIG. 19 is a left elevation view of the projectile of FIG. 15;
 FIG. 20 is a right elevation view of the projectile of FIG. 15;
 FIG. 21 is a perspective view of a projectile according to an alternative embodiment, where the projectile is symmetrical around its longitudinal axis when split into thirds;
 FIG. 22 is a front elevation view of the projectile of FIG. 21, which is a mirror image of the rear elevation view;
 FIG. 23 is a bottom plan view of the projectile of FIG. 21;
 FIG. 24 is a top plan view of the projectile of FIG. 21;
 FIG. 25 is a left elevation view of the projectile of FIG. 21;
 FIG. 26 is a right elevation view of the projectile of FIG. 21;
 FIG. 27 is a perspective view of a projectile according to an alternative embodiment, where the projectile is symmetrical around its longitudinal axis when split into thirds;
 FIG. 28 is a front elevation view of the projectile of FIG. 27;
 FIG. 29 is a rear elevation view of the projectile of FIG. 27;
 FIG. 30 is a top plan view of the projectile of FIG. 27;
 FIG. 31 is a bottom plan view of the projectile of FIG. 27;
 FIG. 32 is a left elevation view of the projectile of FIG. 27;
 FIG. 33 is a right elevation view of the projectile of FIG. 27;
 FIG. 34 is a perspective view of a projectile according to an alternative embodiment, where the projectile is symmetrical around its longitudinal axis when split into thirds;
 FIG. 35 is a front elevation view of the projectile of FIG. 34;
 FIG. 36 is a rear elevation view of the projectile of FIG. 34;
 FIG. 37 is a top plan view of the projectile of FIG. 34;
 FIG. 38 is a bottom plan view of the projectile of FIG. 34;
 FIG. 39 is a left elevation view of the projectile of FIG. 34;
 FIG. 40 is a right elevation view of the projectile of FIG. 34;
 FIG. 41 is a perspective view of a projectile according to an alternative embodiment, where the projectile is symmetrical around its longitudinal axis when split into thirds;
 FIG. 42 is a top plan view of the projectile of FIG. 41;

FIG. 43 is a bottom plan view of the projectile of FIG. 41;
 FIG. 44 is a front elevation view of the projectile of FIG. 41;
 FIG. 45 is a rear elevation view of the projectile of FIG. 41;
 FIG. 46 is a left elevation view of the projectile of FIG. 41;
 FIG. 47 is a right elevation view of the projectile of FIG. 41;
 FIG. 48 is a perspective view of a projectile according to an alternative embodiment, where the projectile is symmetrical around the longitudinal axis when split into thirds;
 FIG. 49 is a bottom plan view of the projectile of FIG. 48;
 FIG. 50 is a top plan view of the projectile of FIG. 48;
 FIG. 51 is a front elevation view of the projectile of FIG. 48, which is a mirror image of the rear elevation view;
 FIG. 52 is a left elevation view of the projectile of FIG. 48;
 FIG. 53 is a right elevation view of the projectile of FIG. 48;
 FIG. 54 is a perspective view of a projectile according to an alternative embodiment;
 FIG. 55 is a front elevation view of the projectile of FIG. 54, which is the same as the rear elevation view, top plan view, and bottom plan view because the projectile is symmetrical around its longitudinal axis;
 FIG. 56 is a left elevation view of the projectile of FIG. 54;
 FIG. 57 is a right elevation view of the projectile of FIG. 54;
 FIG. 58 is a perspective view of a projectile according to an alternative embodiment;
 FIG. 59 is a front elevation view of the projectile of FIG. 58, which is the same as the rear elevation view, top plan view, and bottom plan view because the projectile is symmetrical around its longitudinal axis;
 FIG. 60 is a left elevation view of the projectile of FIG. 58;
 FIG. 61 is a right elevation view of the projectile of FIG. 58;
 FIG. 62 is a perspective view of a projectile according to an alternative embodiment;
 FIG. 63 is a front elevation view of the projectile of FIG. 62, which is the same as the rear elevation view, top plan view, and bottom plan view because the projectile is symmetrical around its longitudinal axis;
 FIG. 64 is a left elevation view of the projectile of FIG. 62;
 FIG. 65 is a right elevation view of the projectile of FIG. 62;
 FIG. 66 is a perspective view of a projectile according to an alternative embodiment;
 FIG. 67 is a front elevation view of the projectile of FIG. 66, which is a mirror image of the rear elevation view;
 FIG. 68 is a top plan view of the projectile of FIG. 66, which is a mirror image of the bottom plan view;
 FIG. 69 is a left elevation view of the projectile of FIG. 66;
 FIG. 70 is a right elevation view of the projectile of FIG. 66;
 FIG. 71 is a perspective view of a projectile according to an alternative embodiment, where the projectile is symmetrical across its horizontal and vertical planes as cut along the longitudinal axis of the projectile;
 FIG. 72 is a front elevation view of the projectile of FIG. 71, which is the same as the rear elevation view, top plan view, and bottom plan view because the projectile is symmetrical around its longitudinal axis; and,
 FIG. 73 is a left elevation view of the projectile of FIG. 71. The broken lines depict portions of the projectile in which the design is embodied that are not considered part of the claimed design.

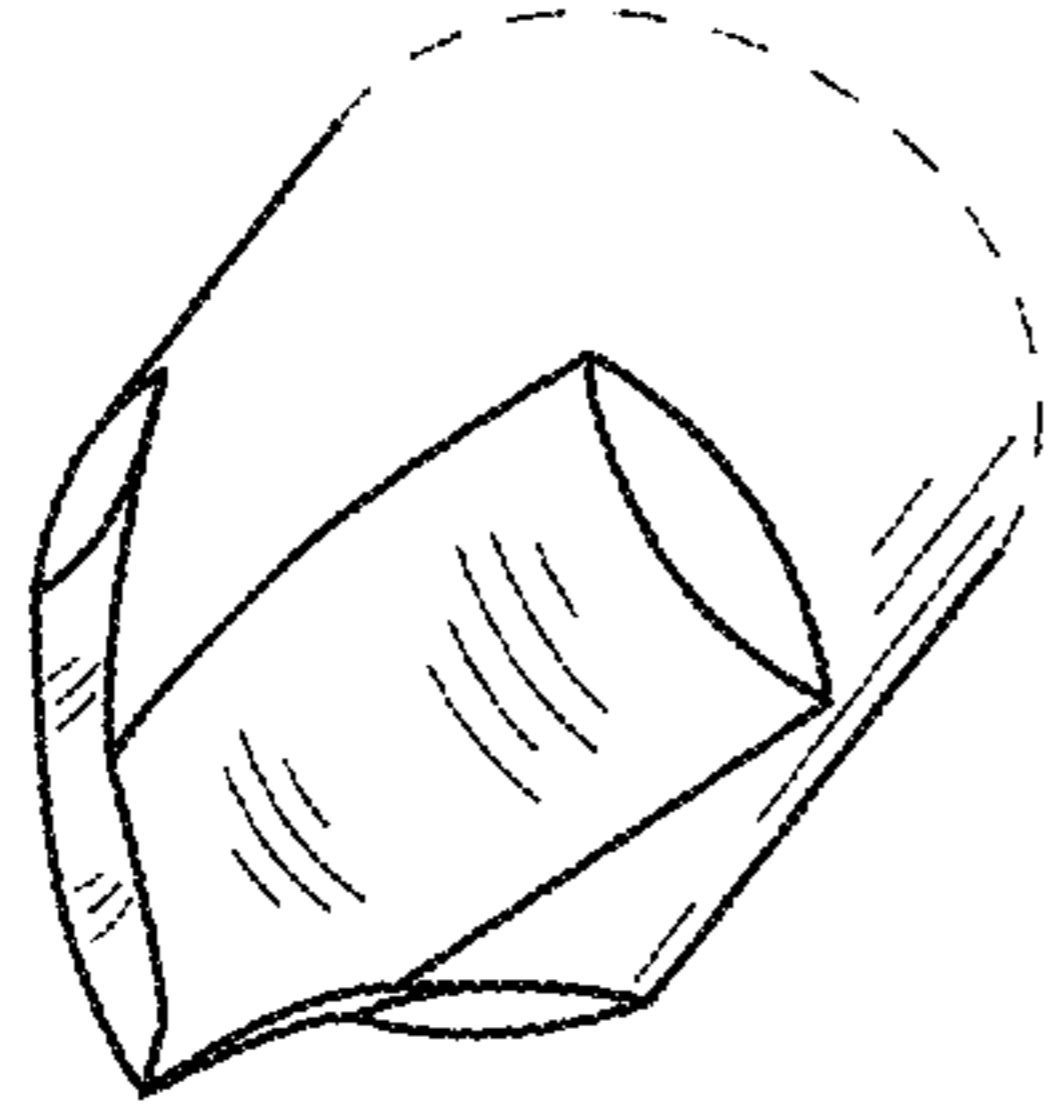

FIG.1

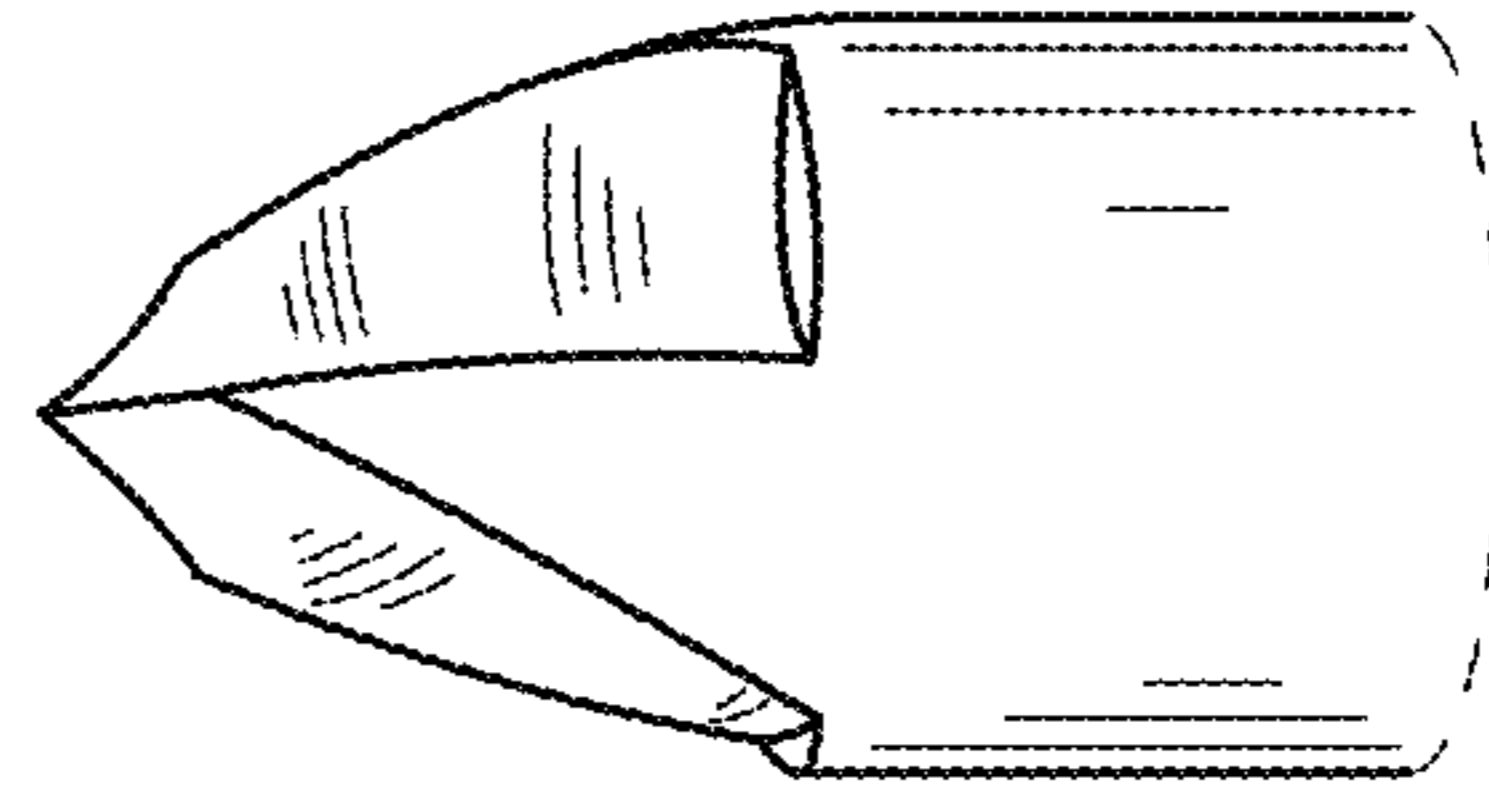

FIG.2

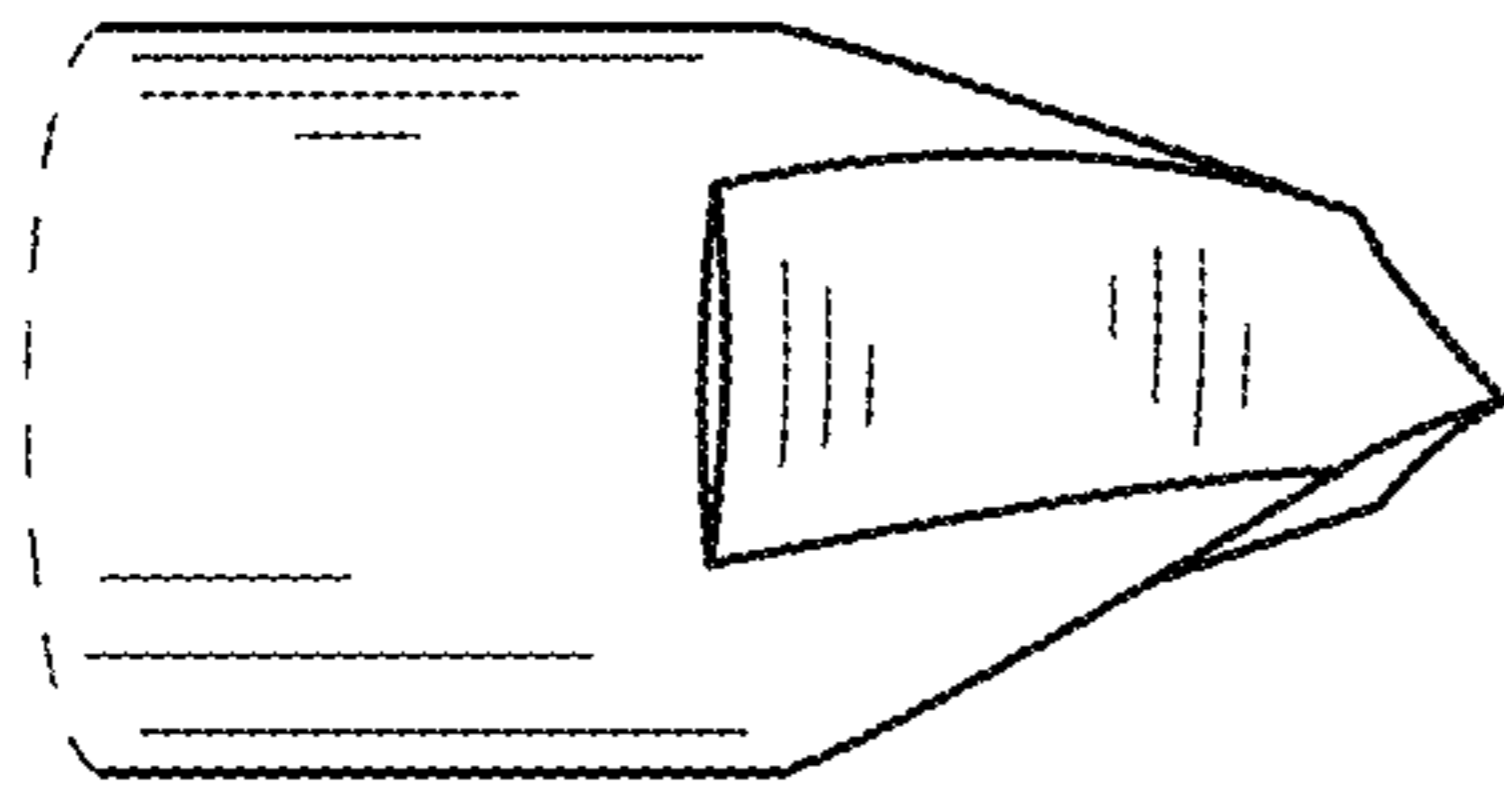

FIG.3

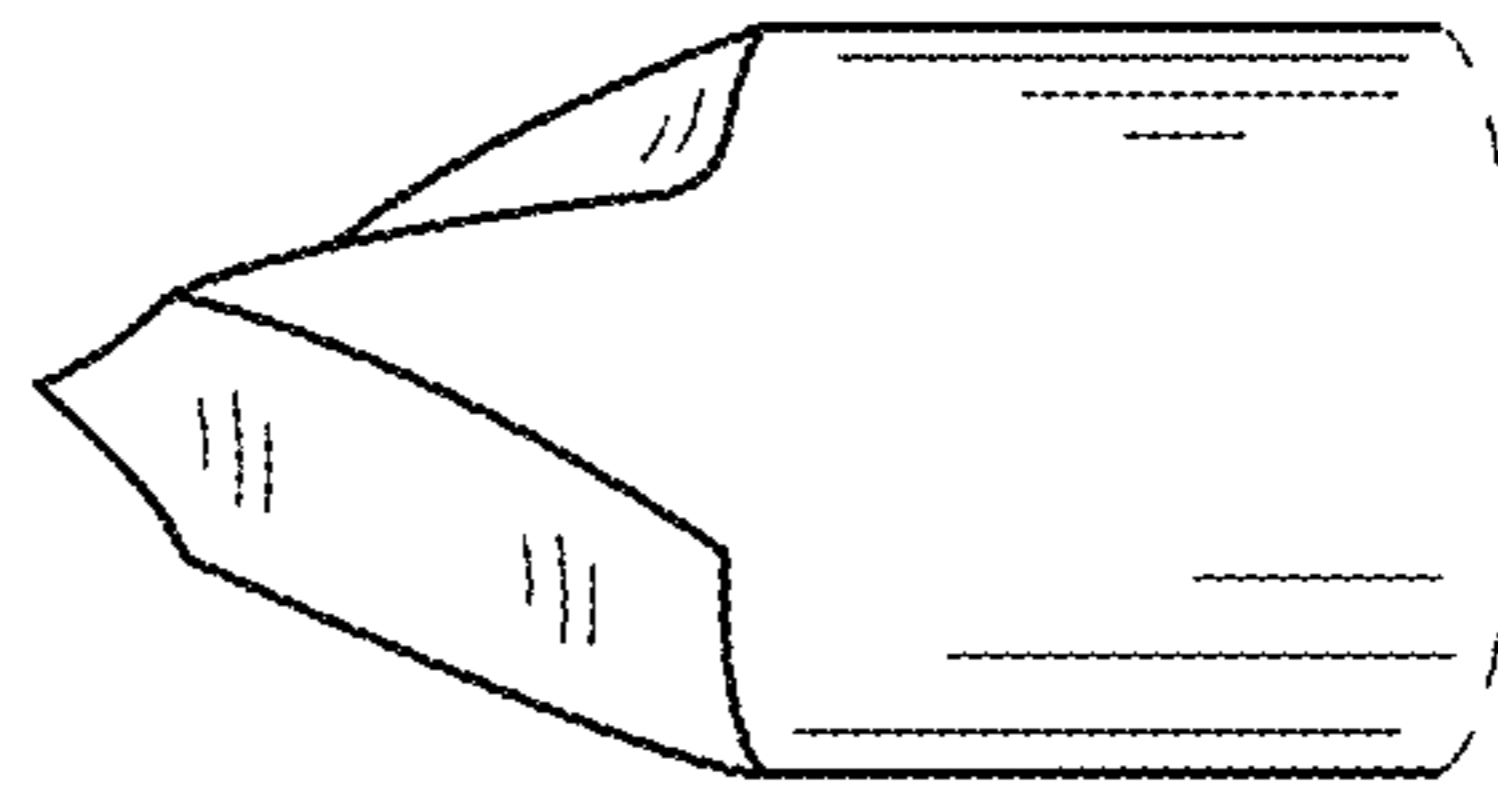

FIG.4

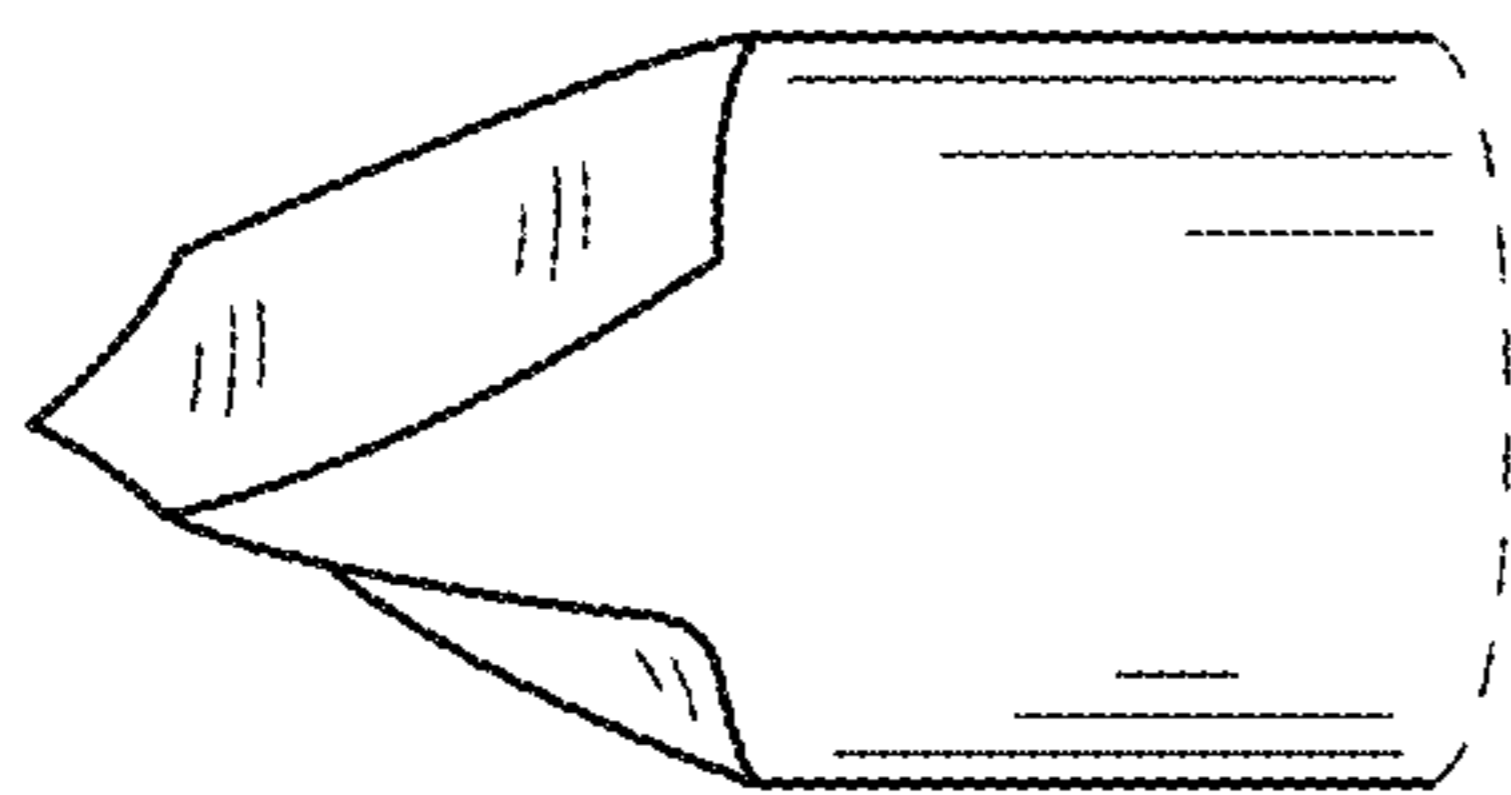

FIG.5

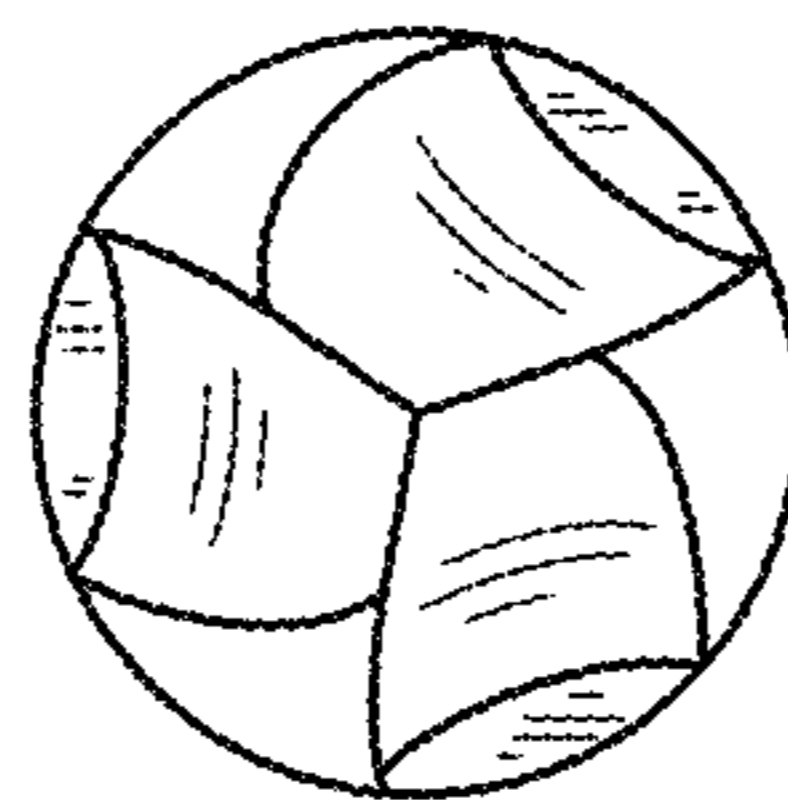

FIG.6

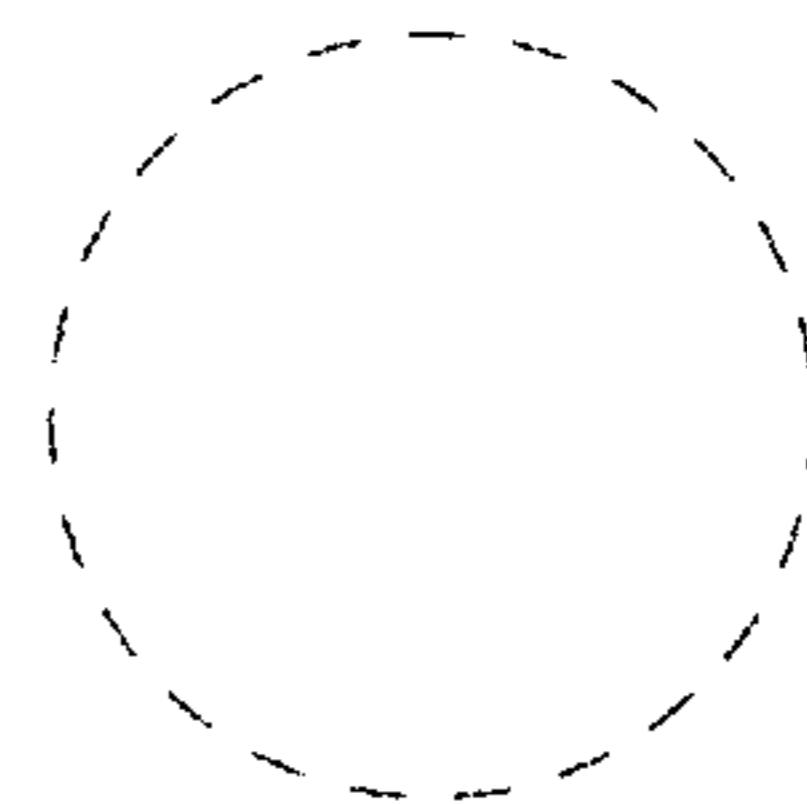

FIG.7

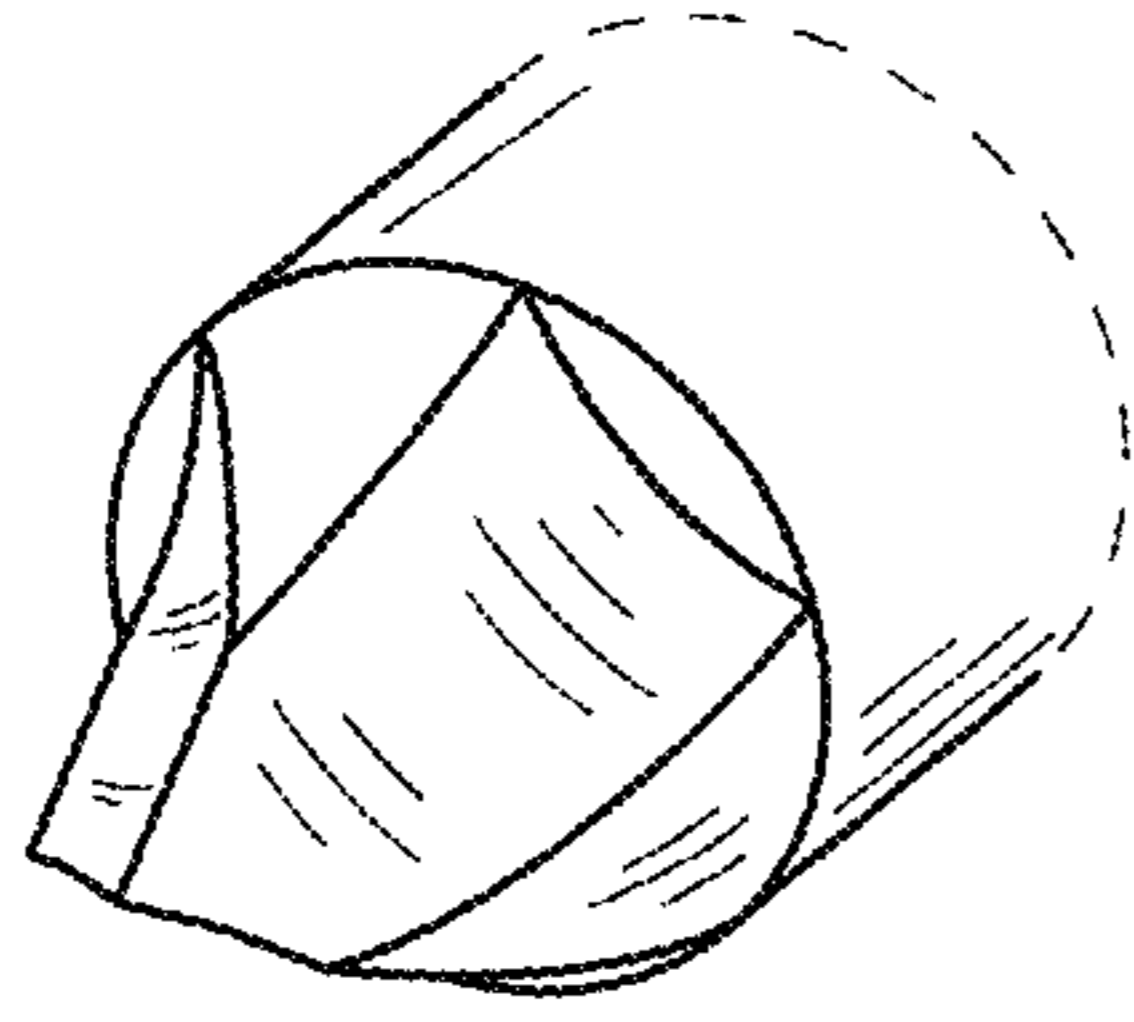

FIG. 8

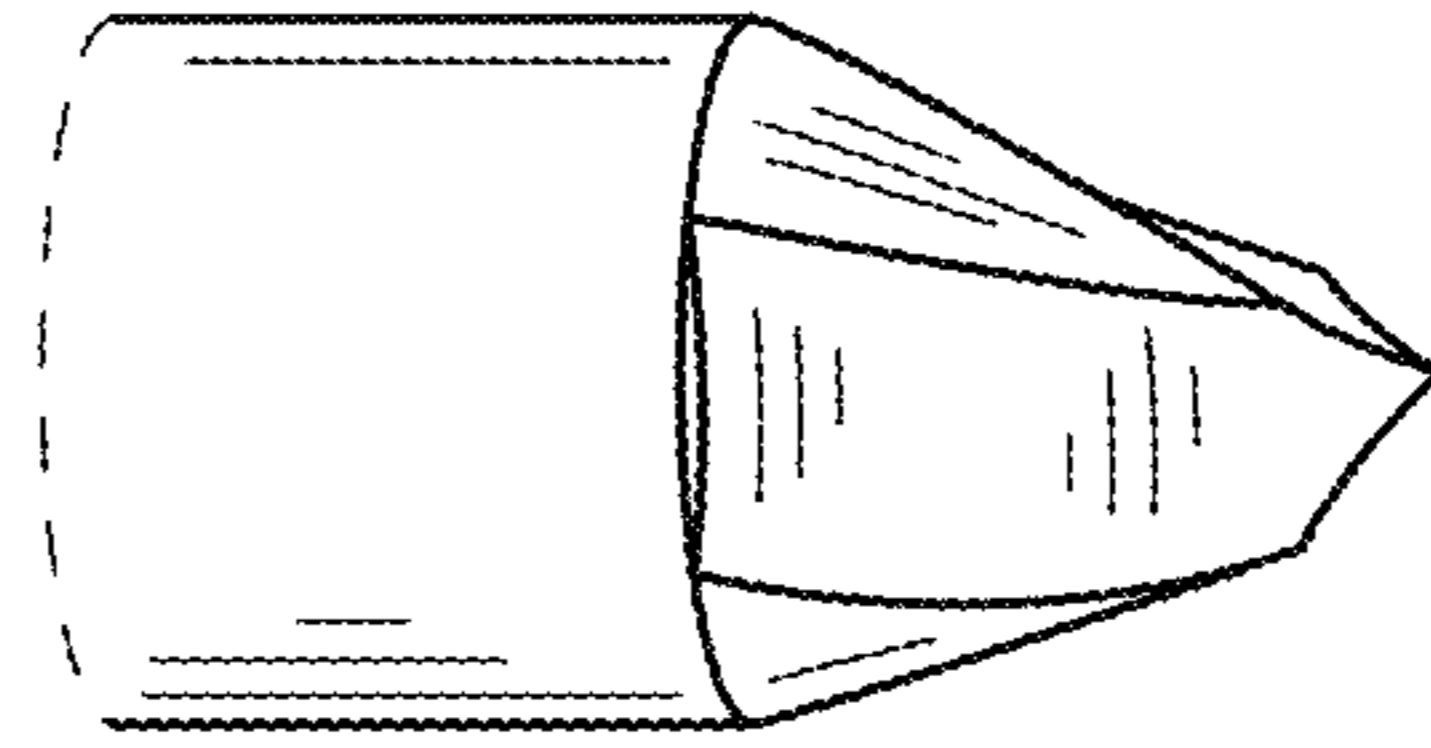

FIG. 9

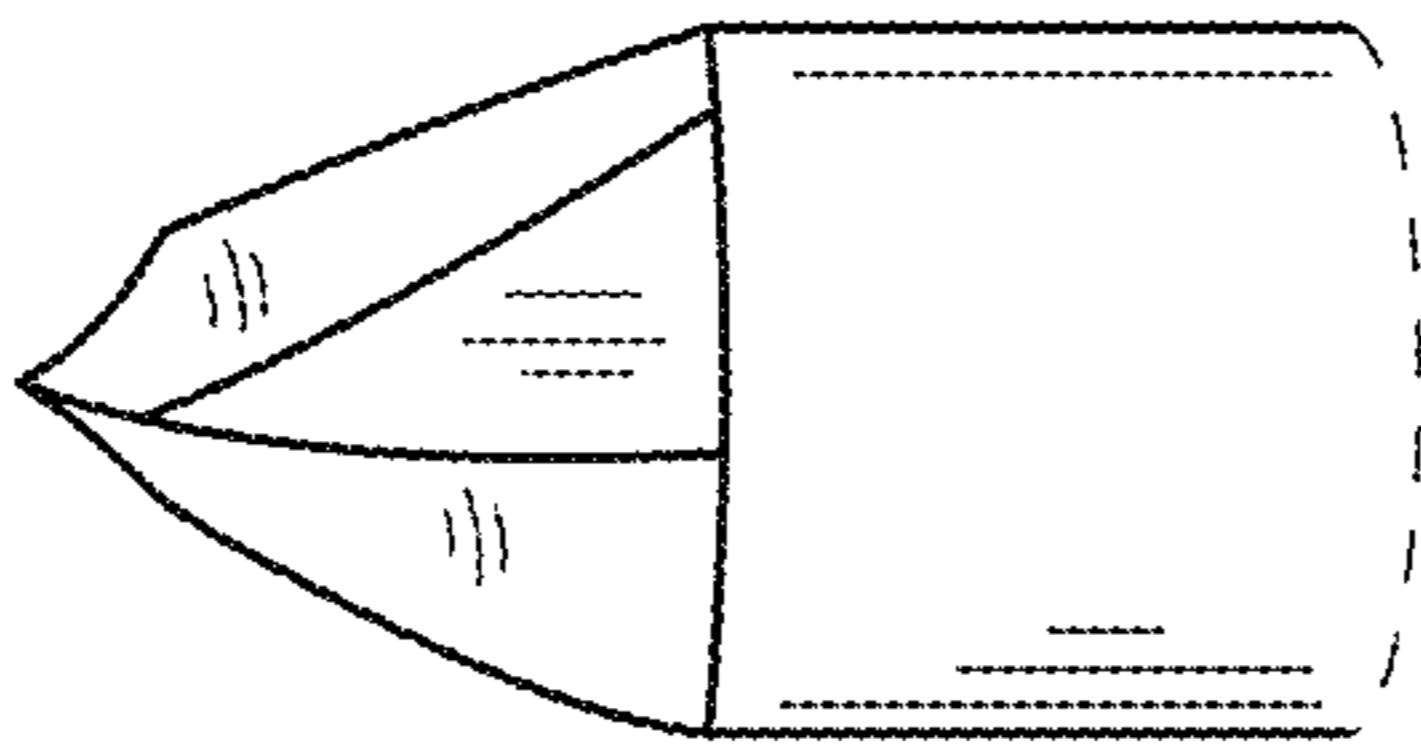

FIG. 10

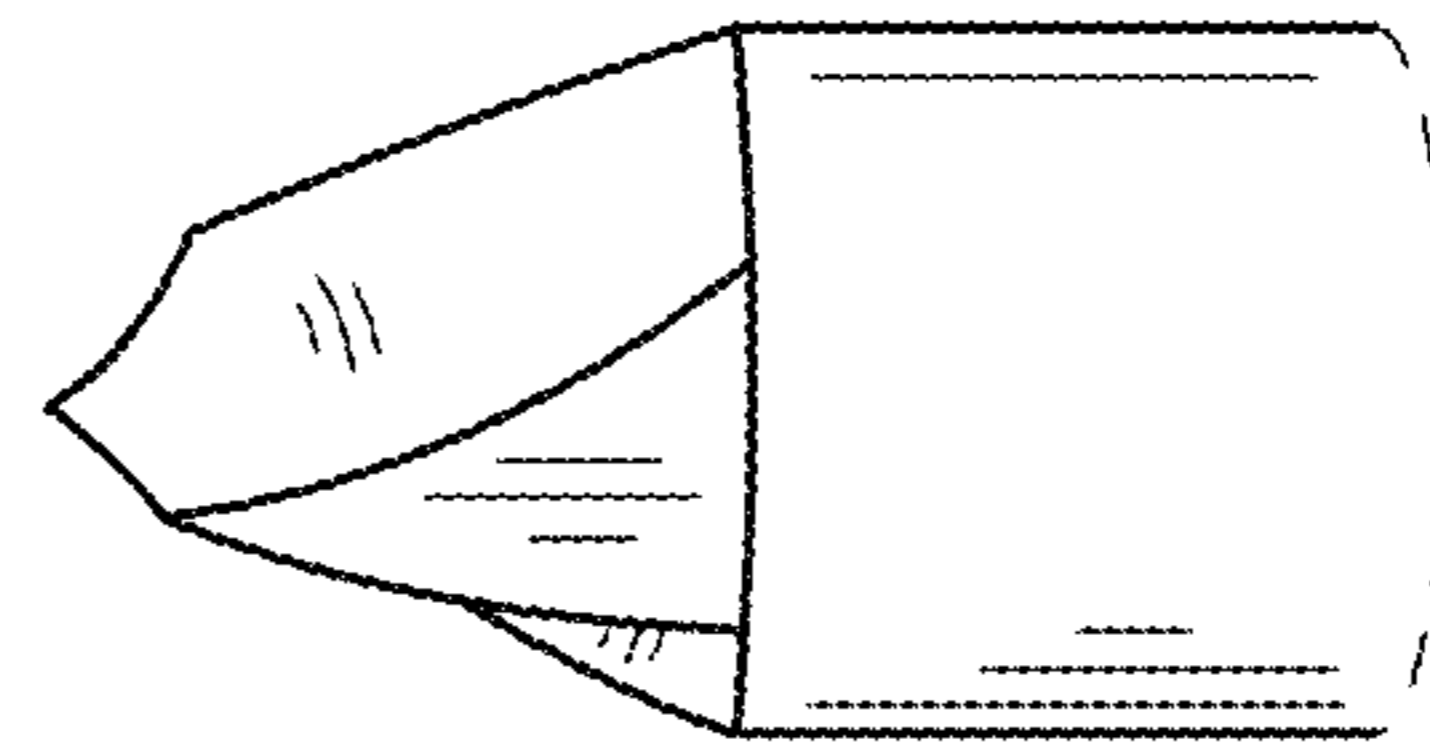

FIG. 11

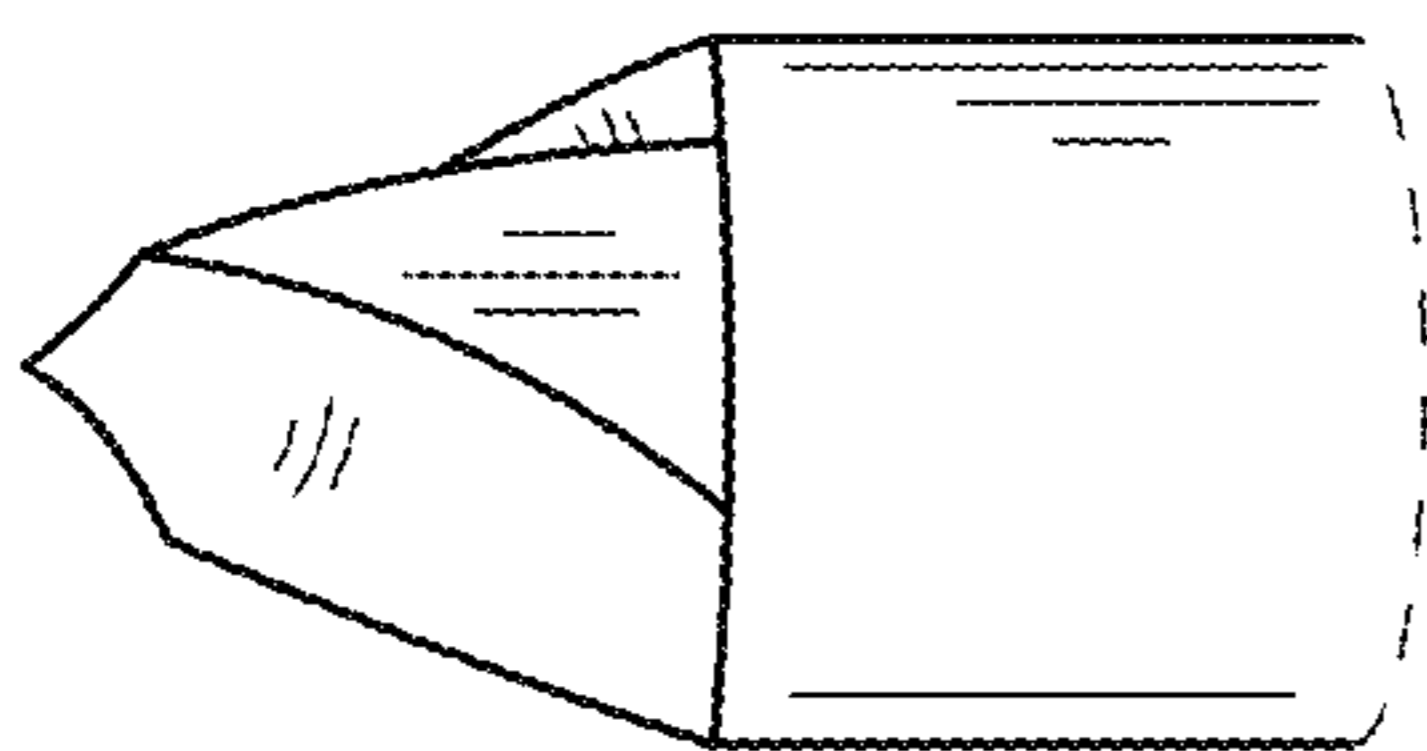

FIG. 12

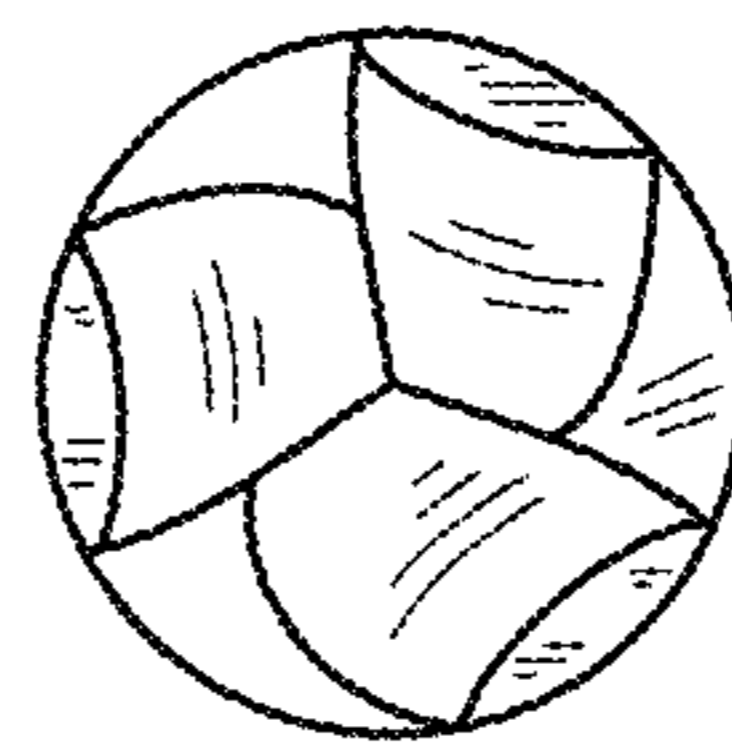

FIG. 13

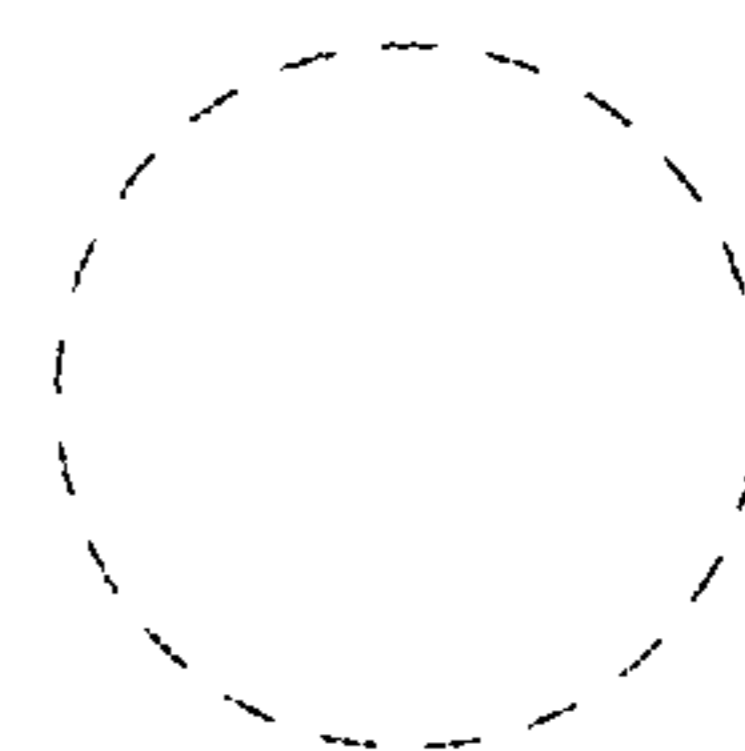

FIG. 14

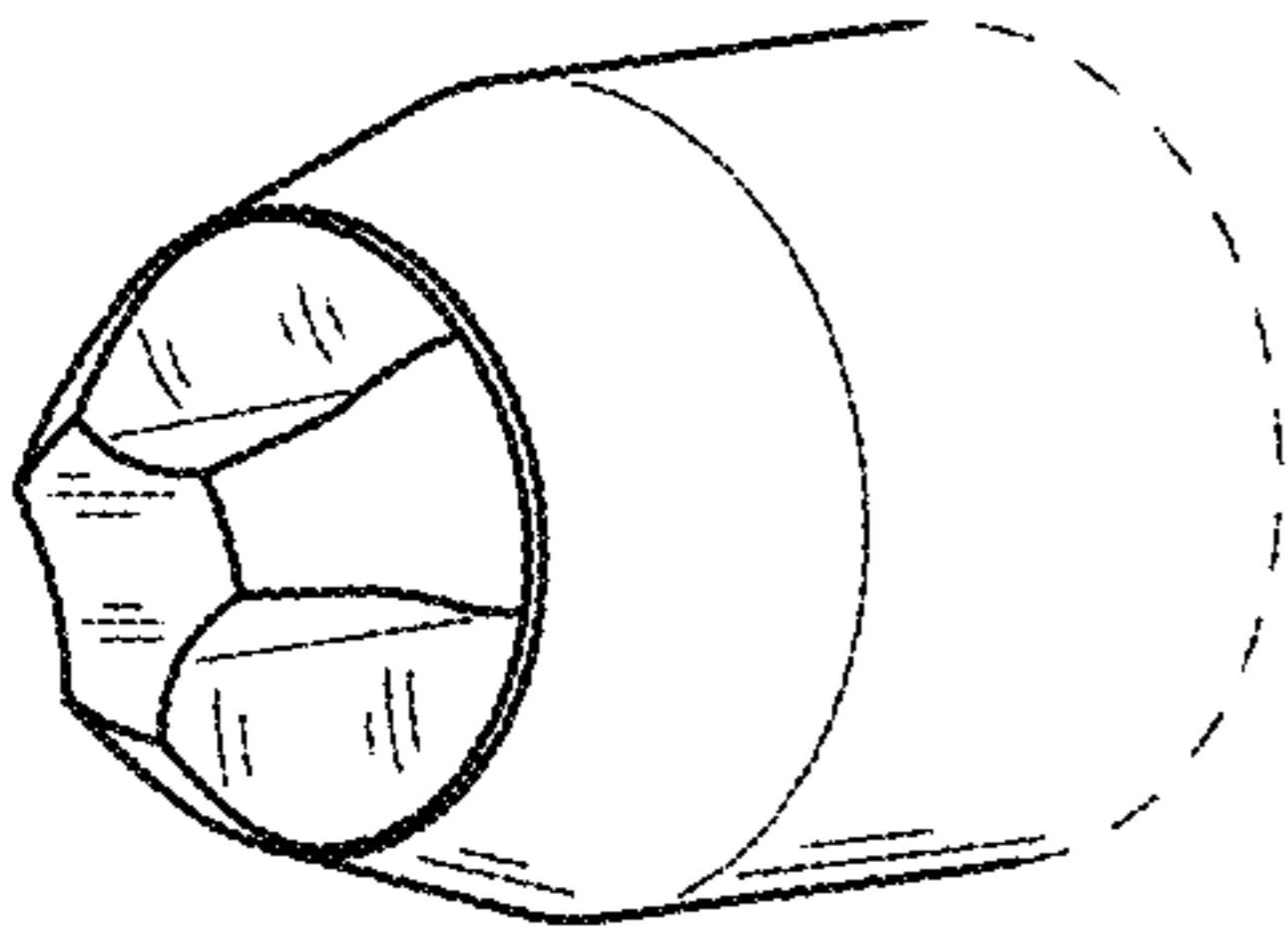

FIG. 15

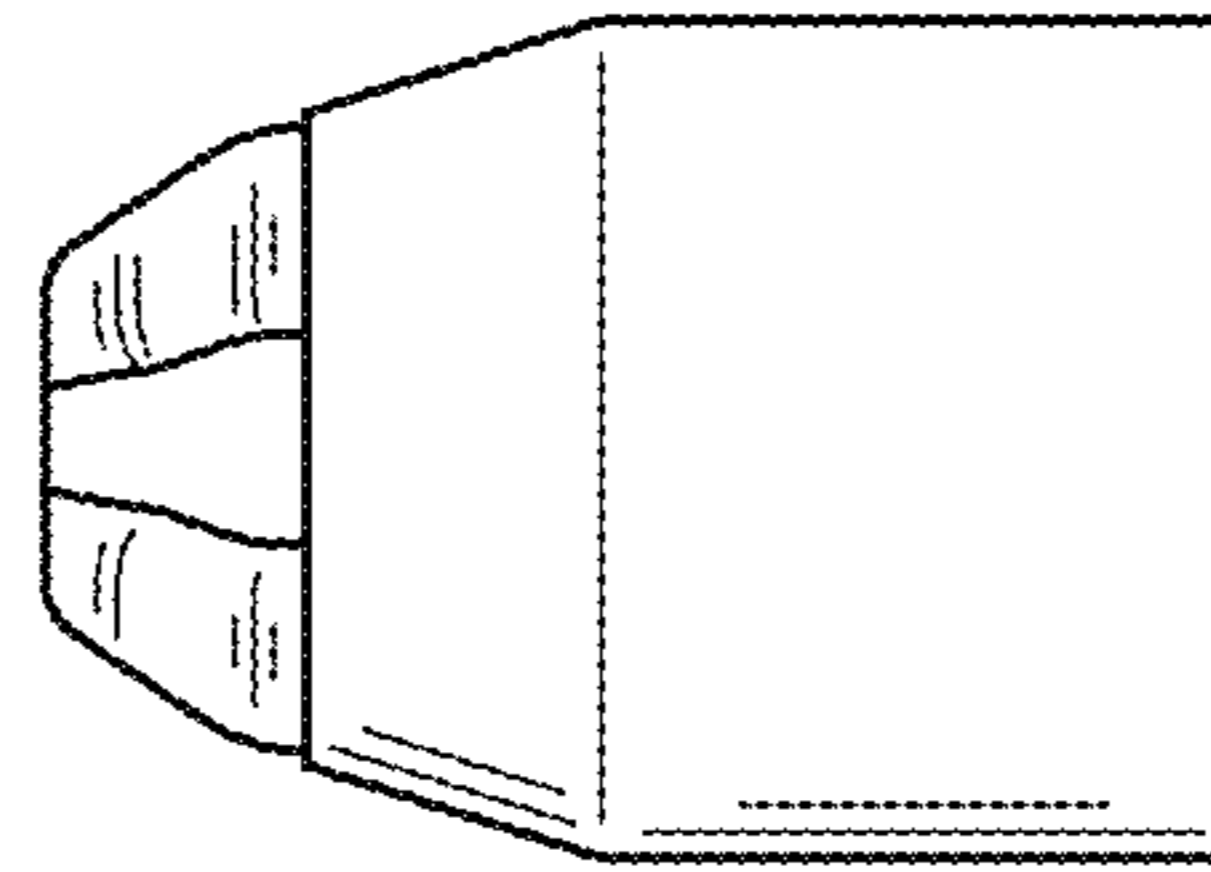

FIG. 16

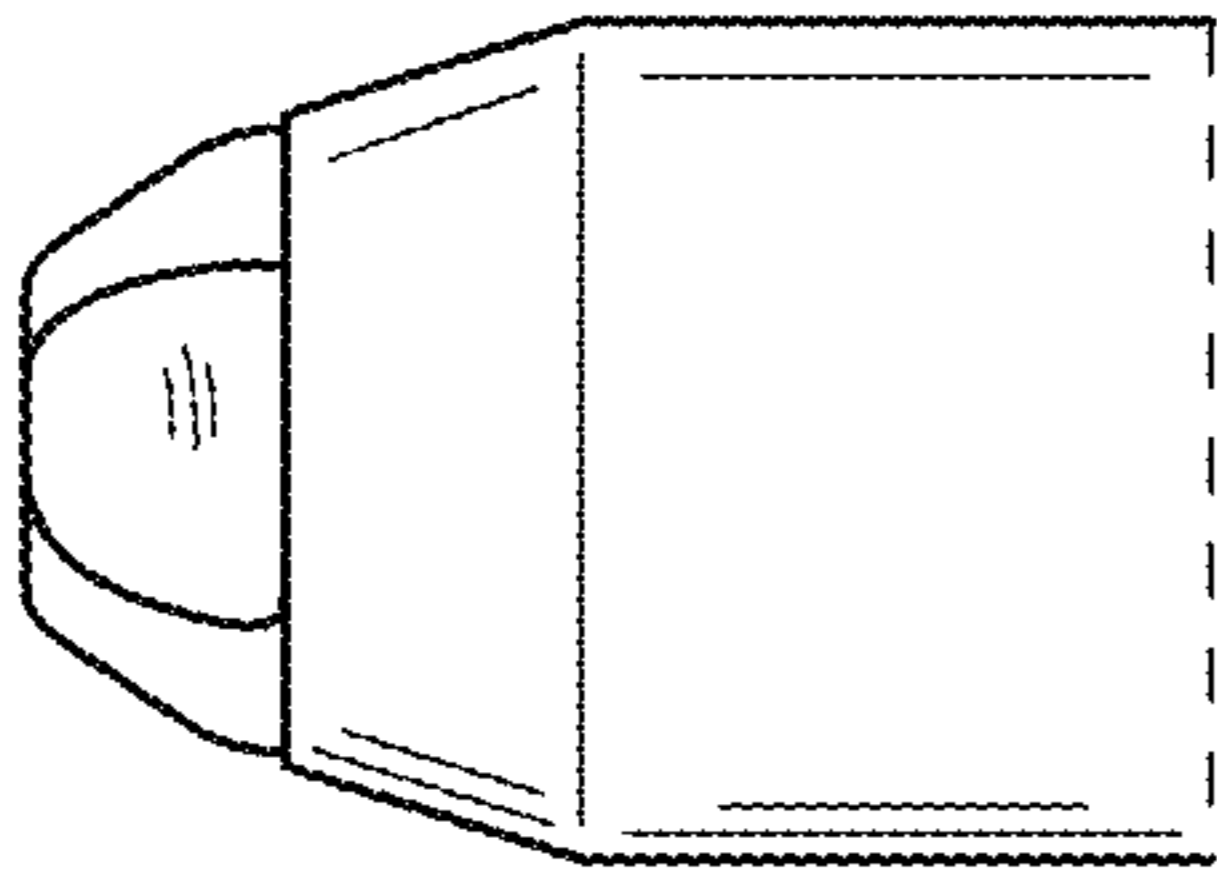

FIG. 17

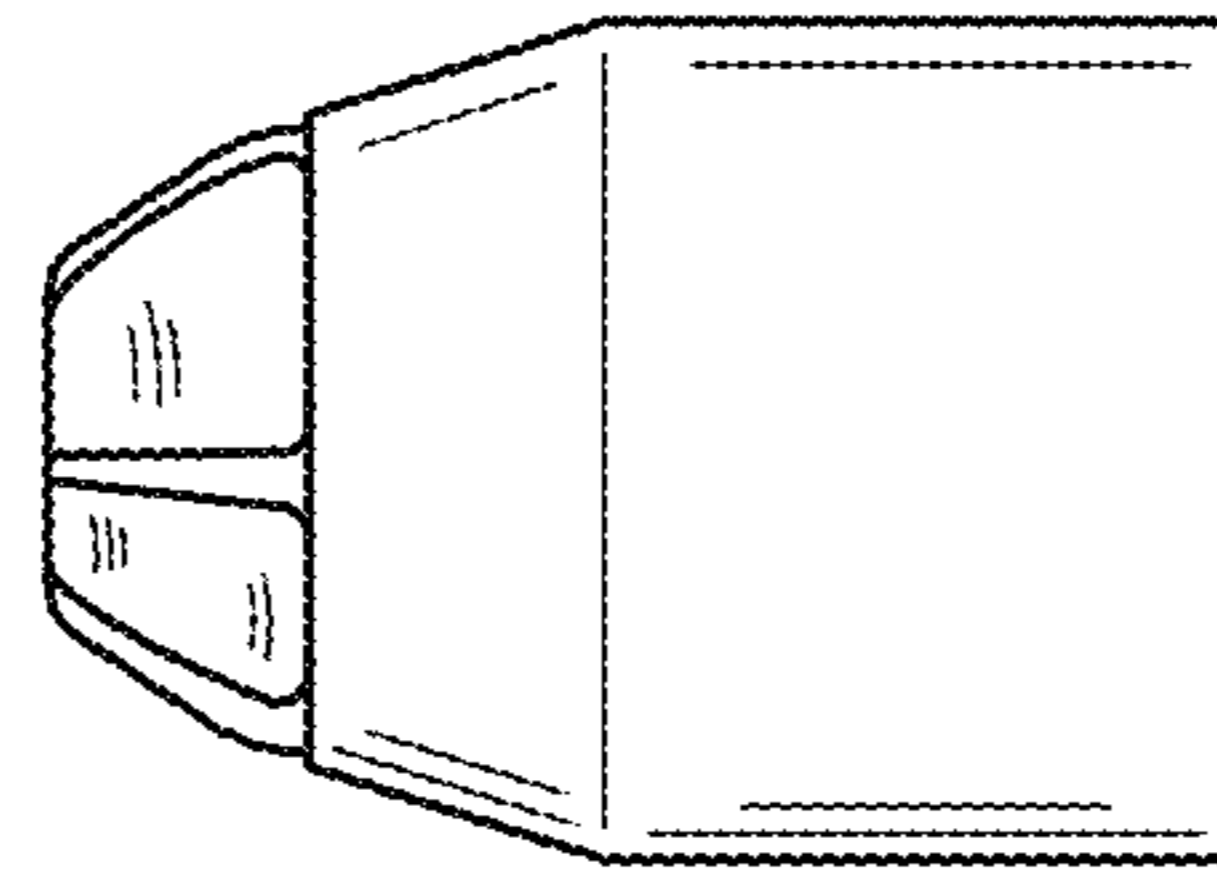

FIG. 18

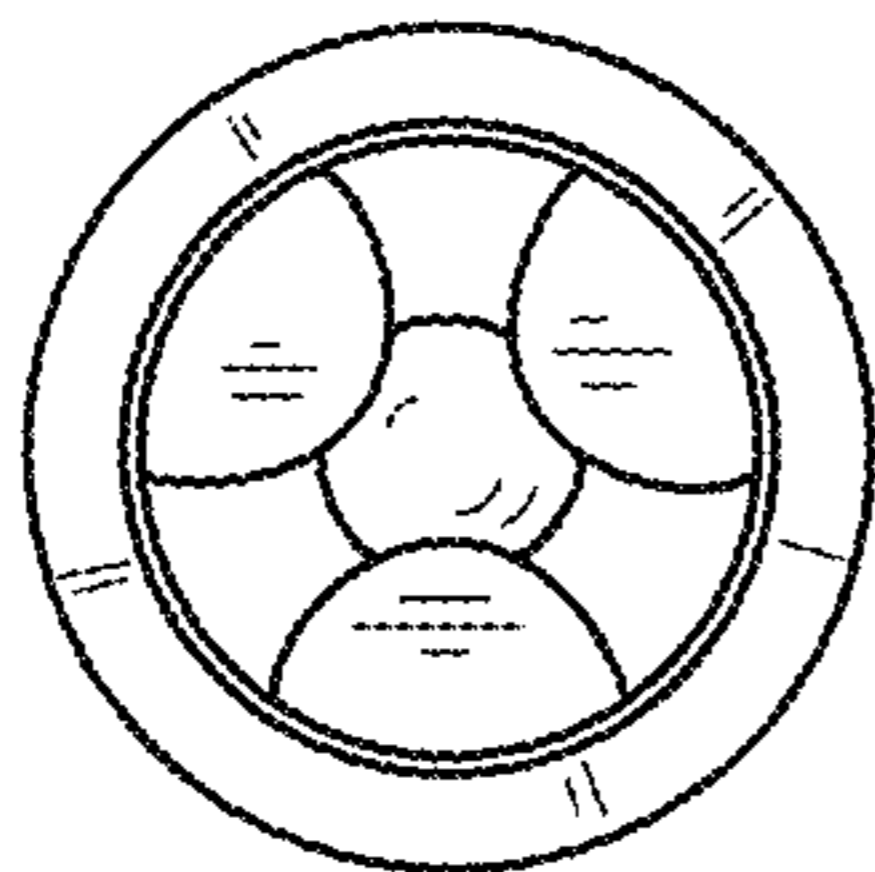

FIG. 19

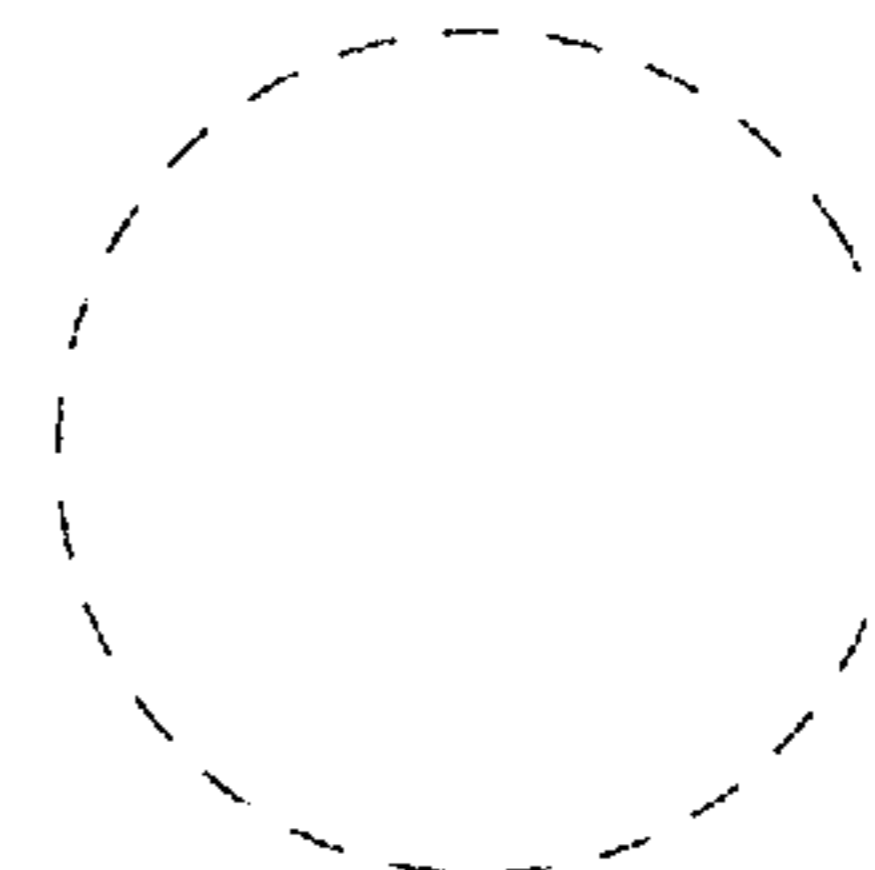

FIG. 20

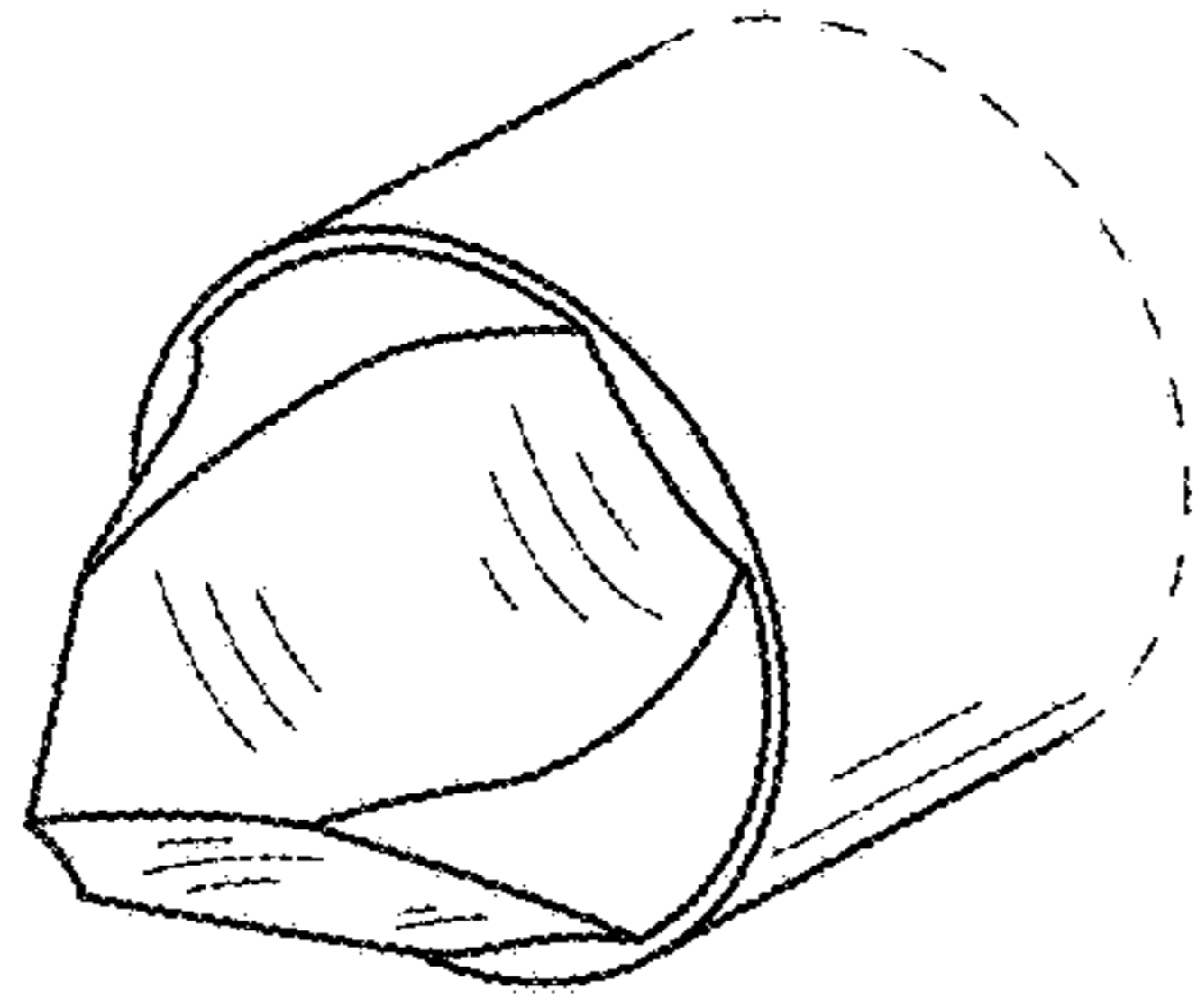

FIG. 21

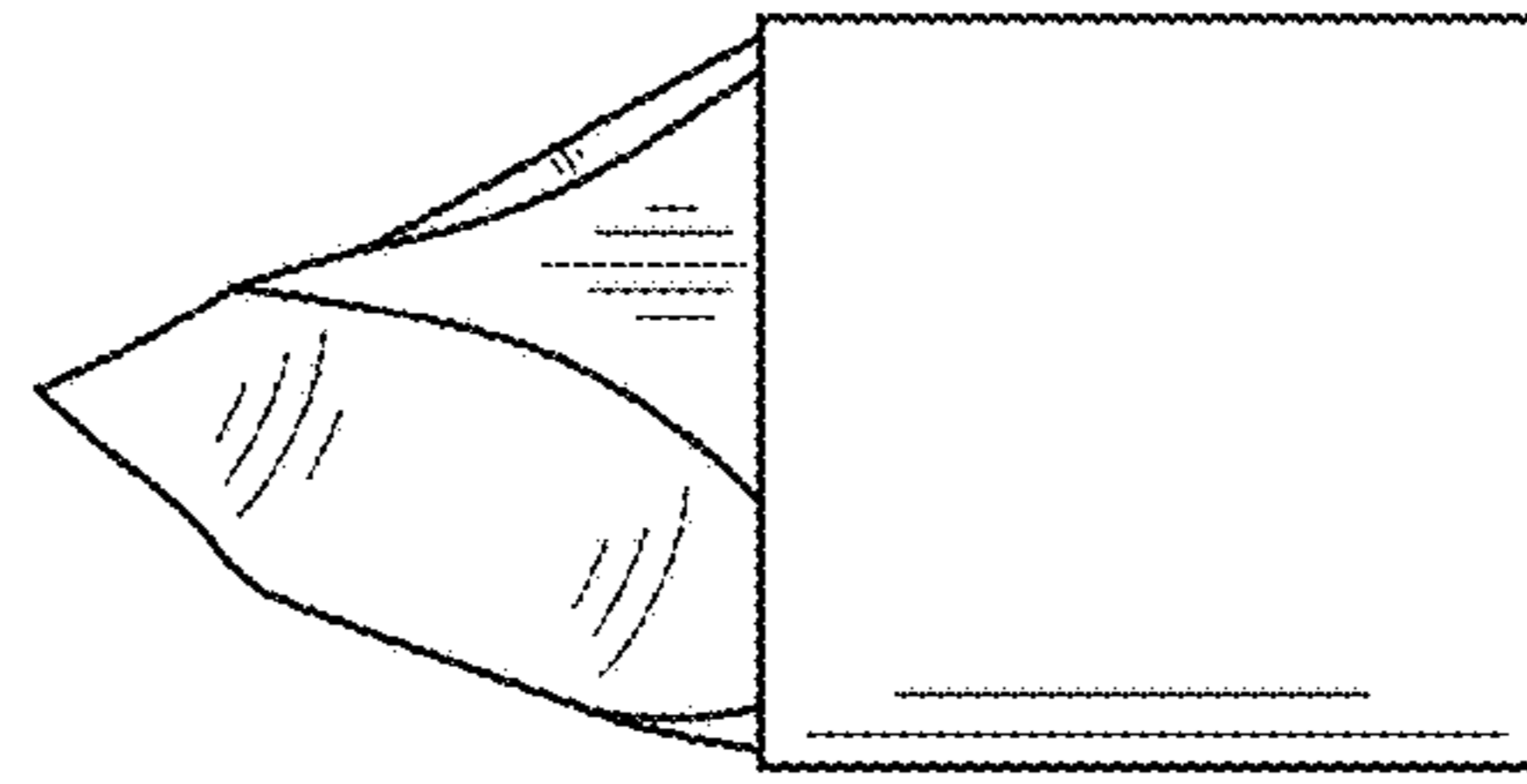

FIG. 22

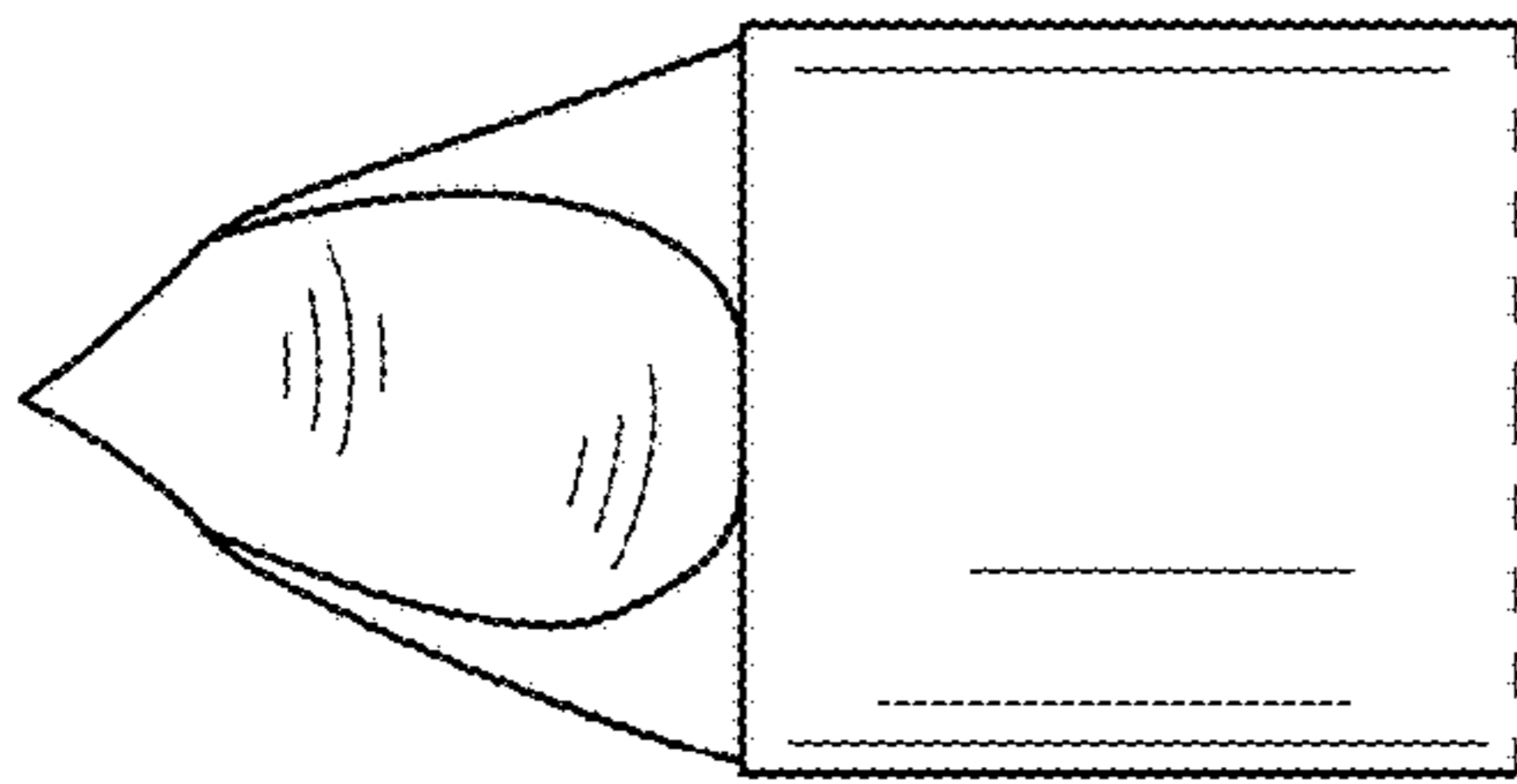

FIG. 23

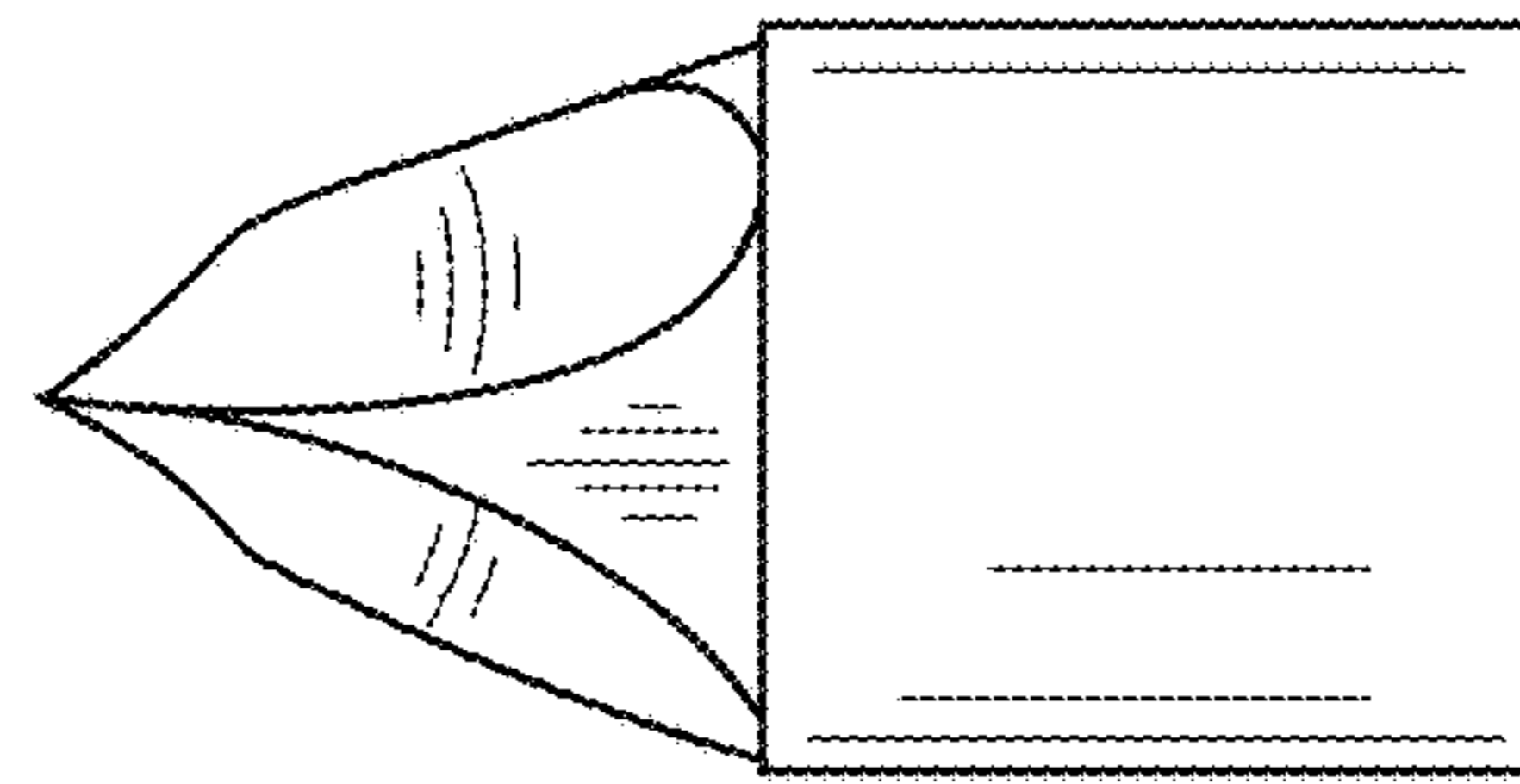

FIG. 24

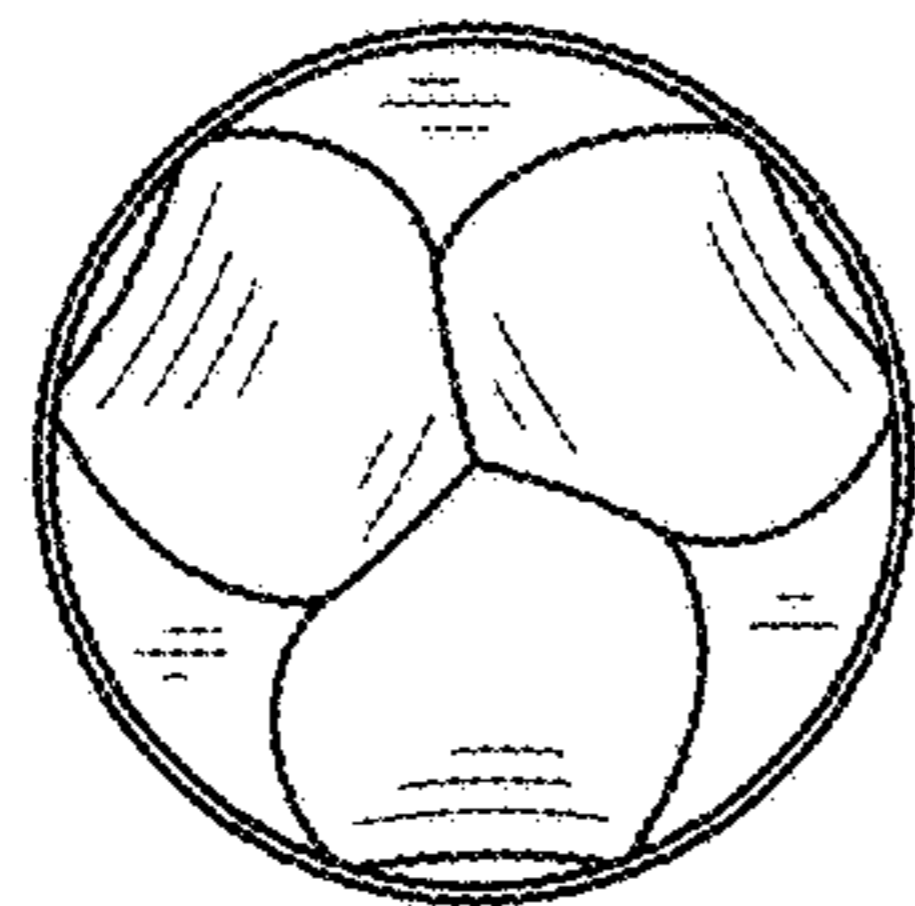

FIG. 25

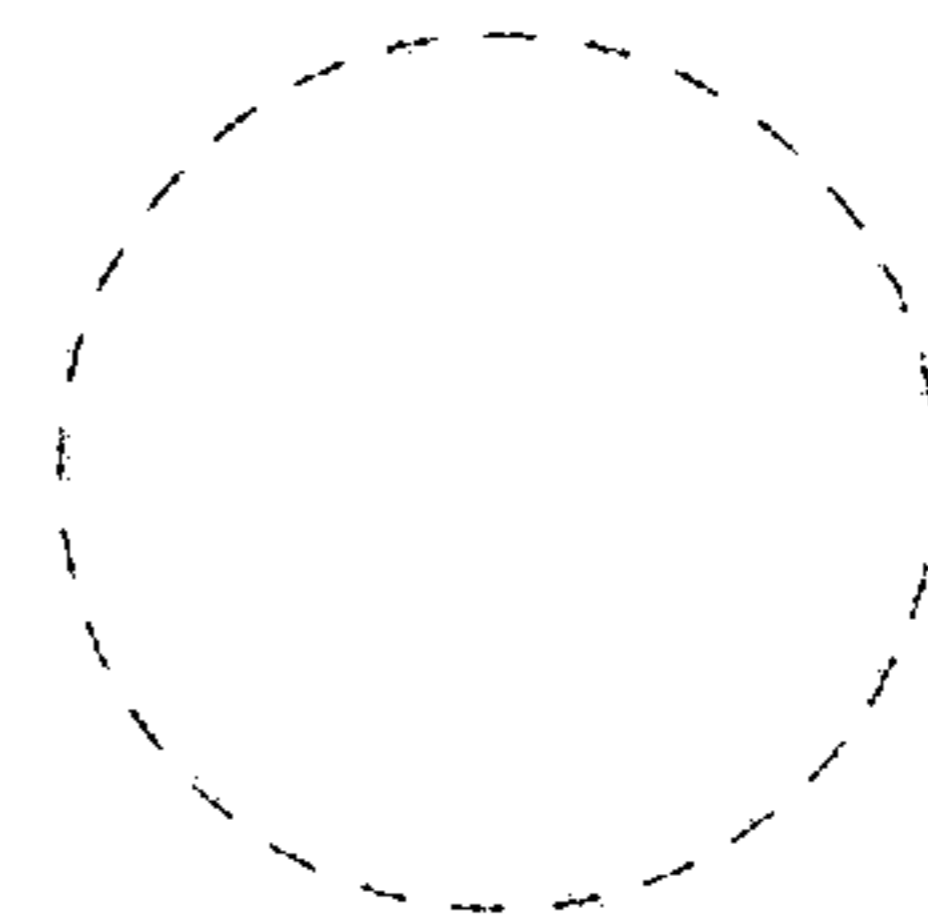

FIG. 26

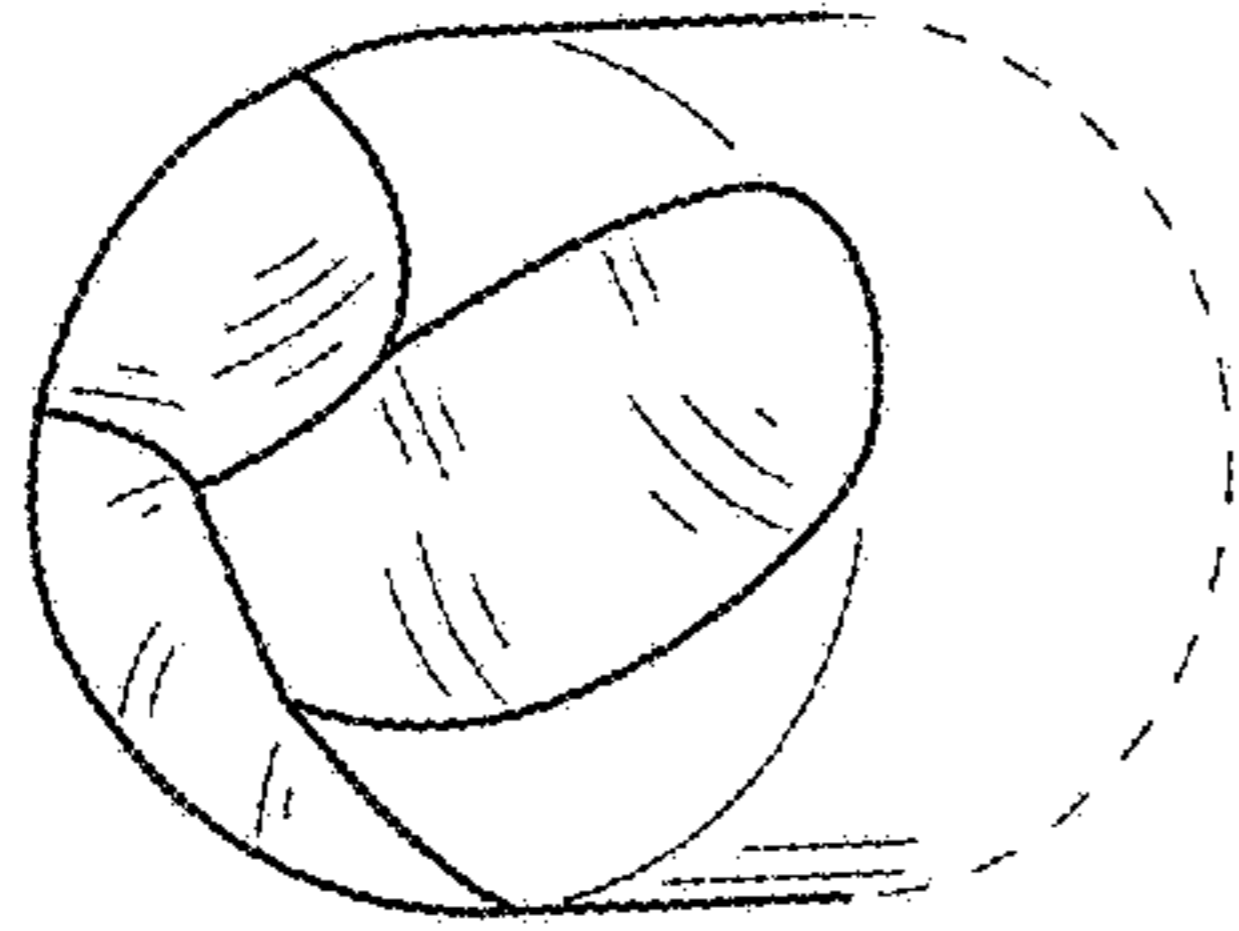

FIG. 27

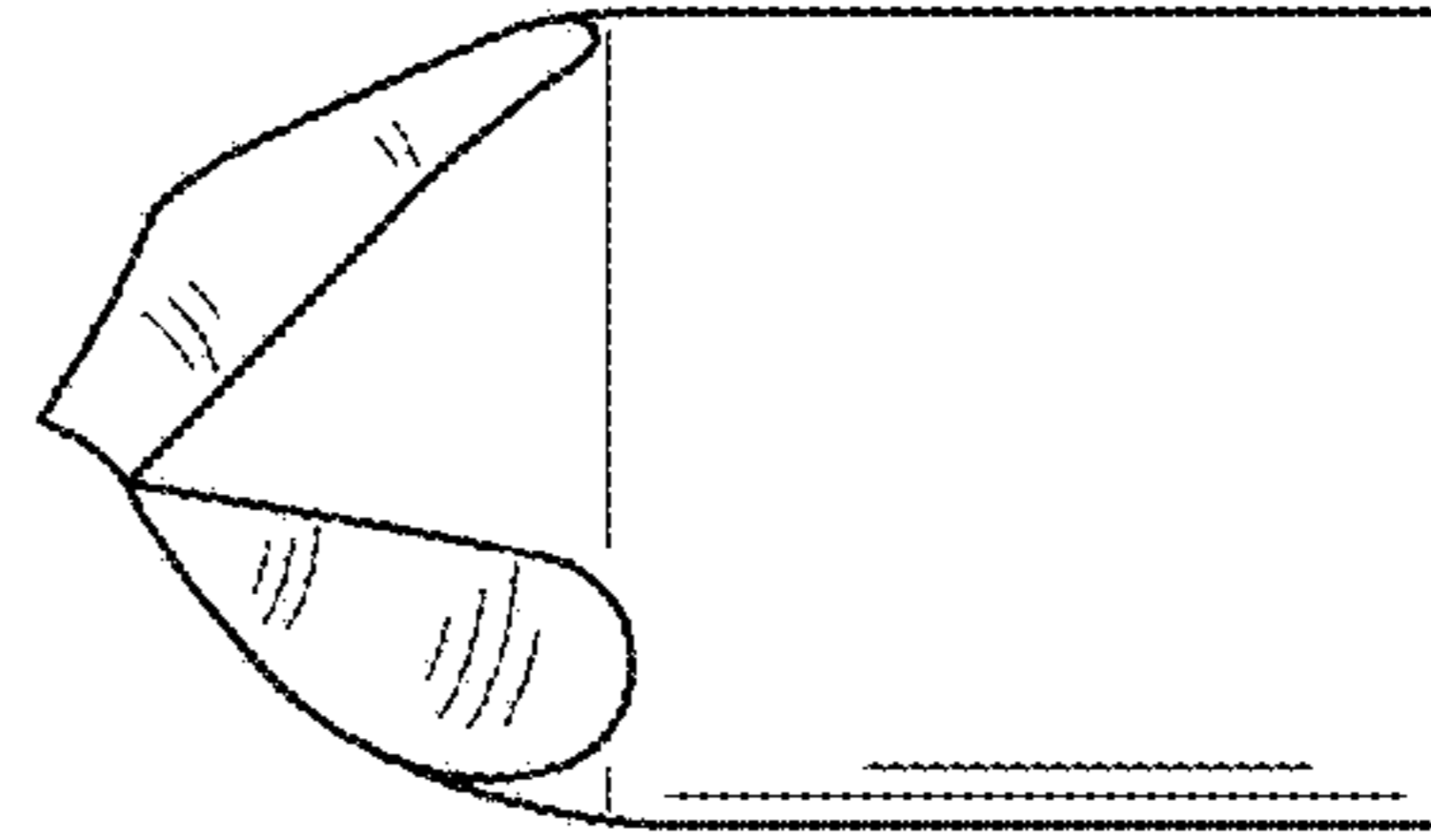

FIG. 28

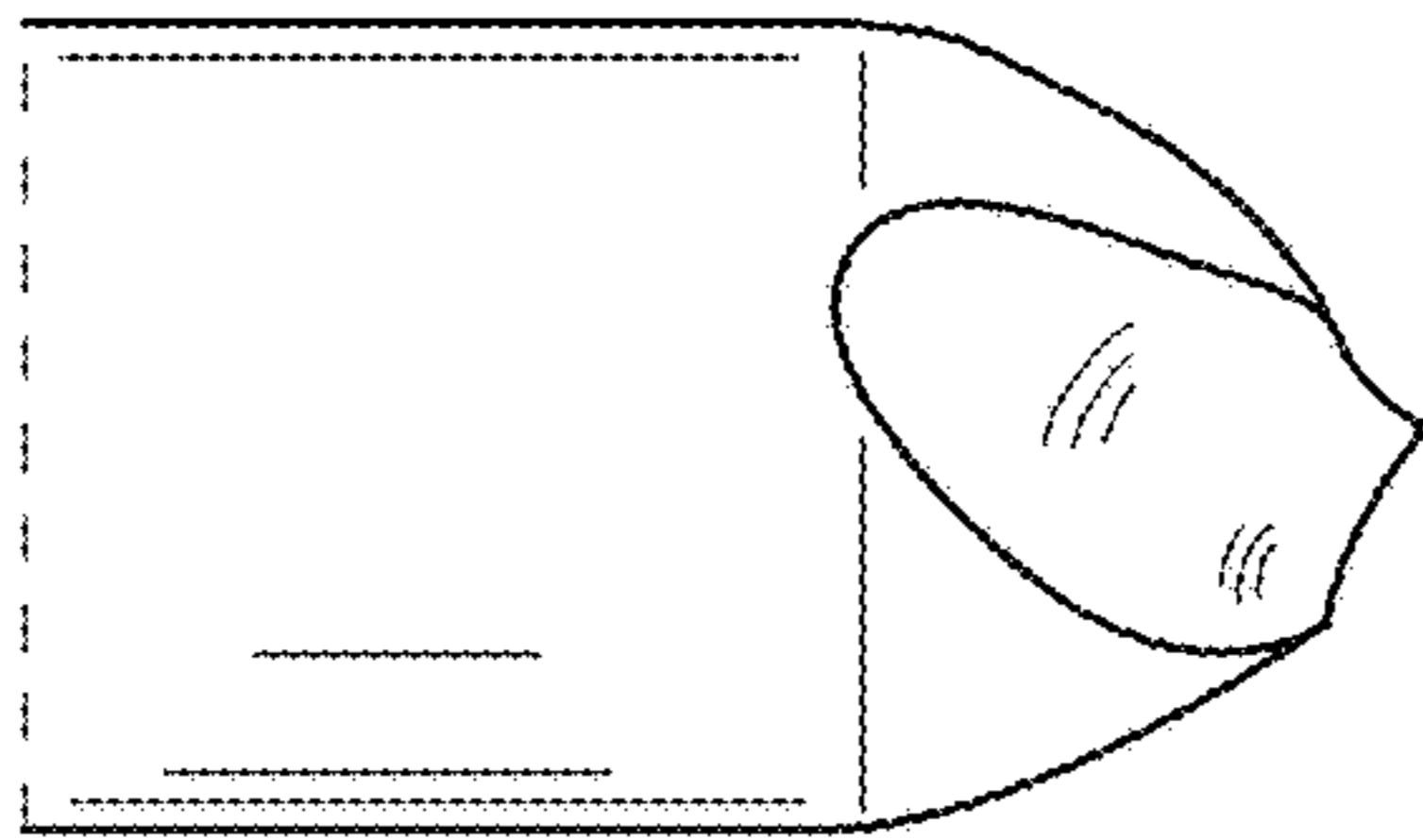

FIG. 29

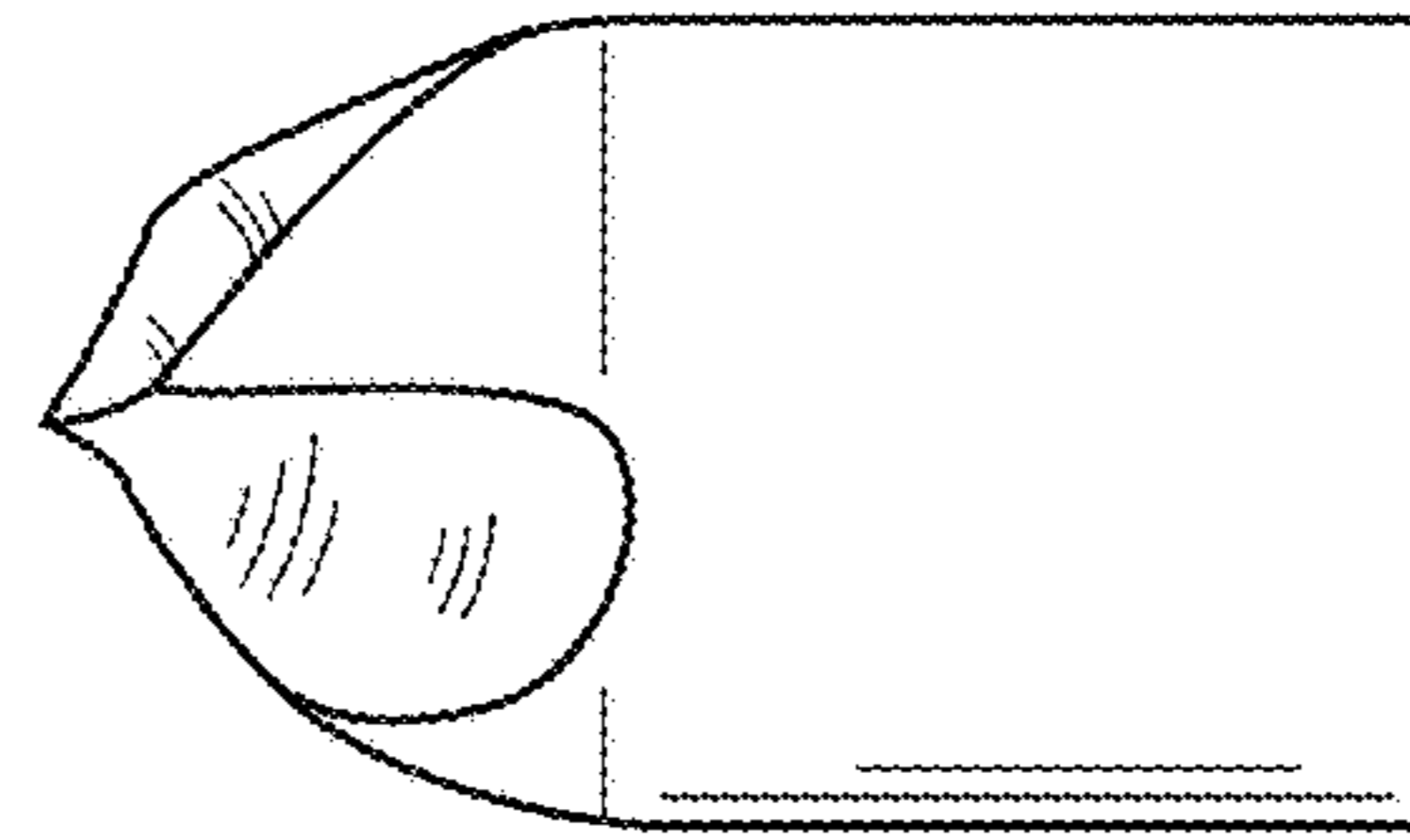

FIG. 30

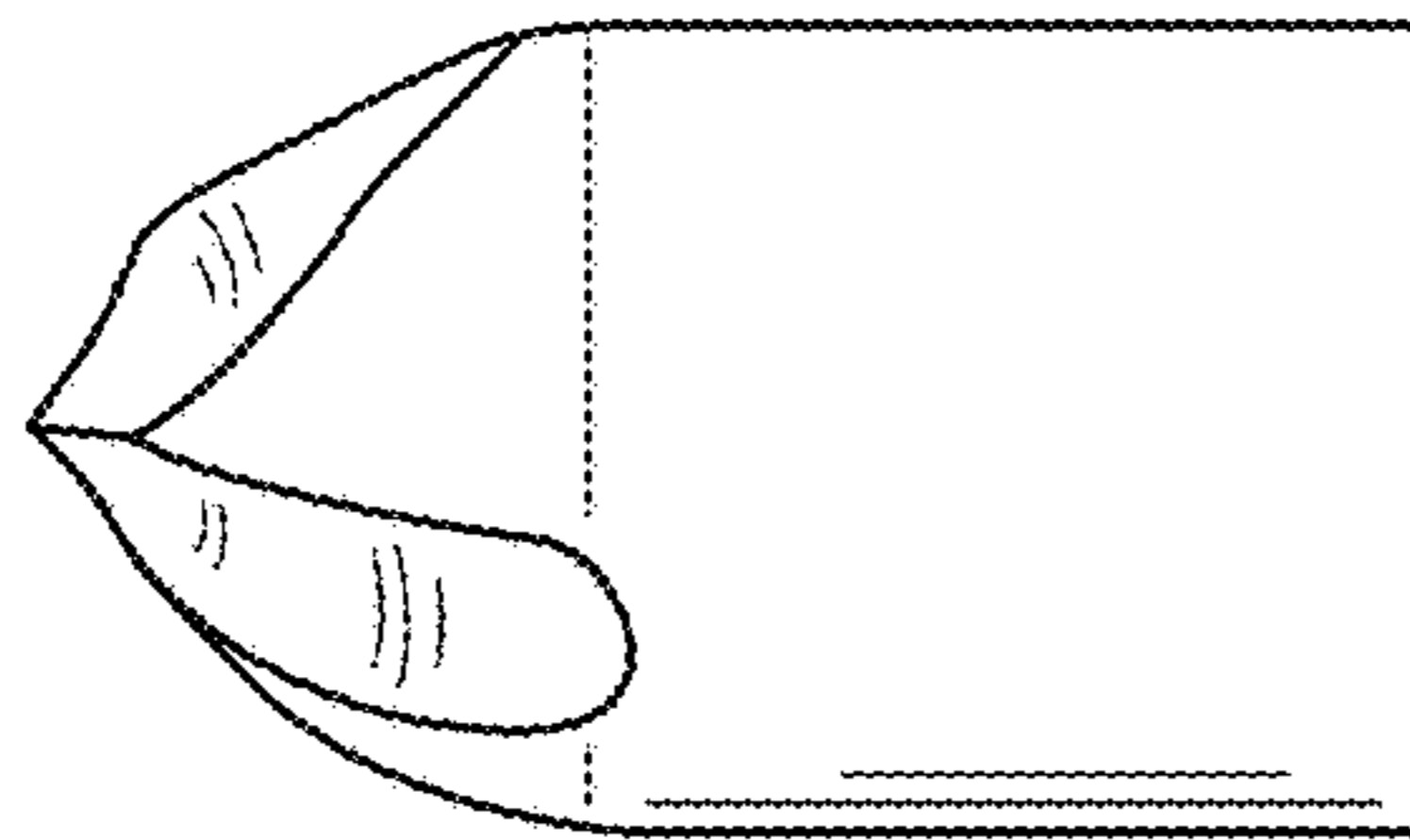

FIG. 31

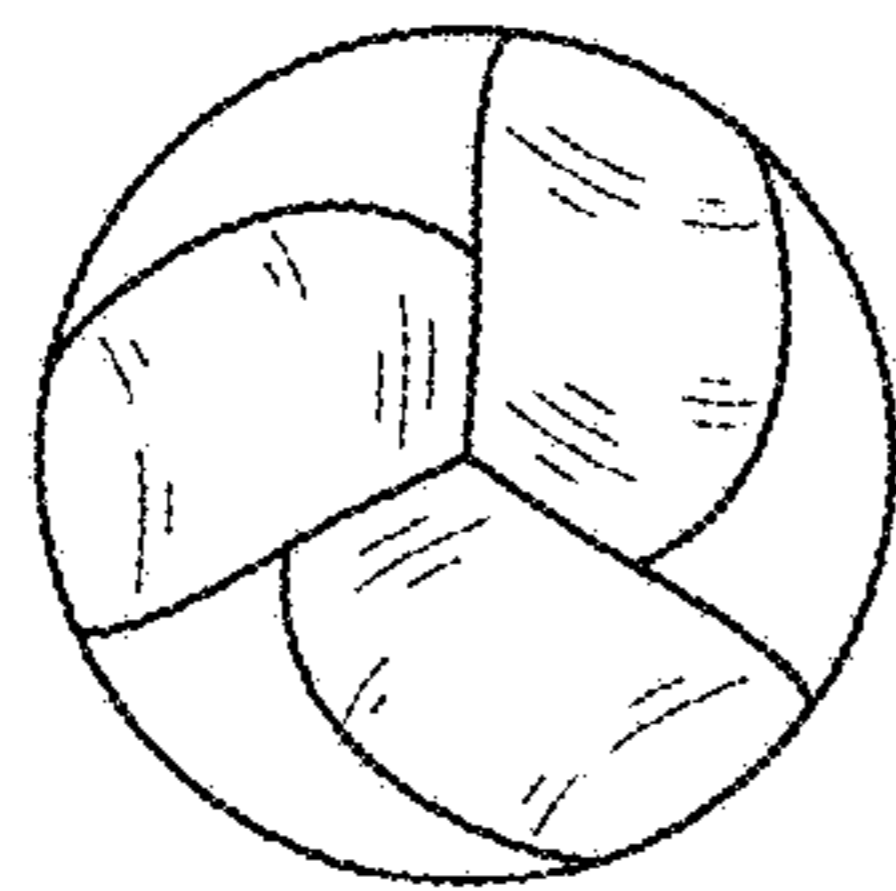

FIG. 32

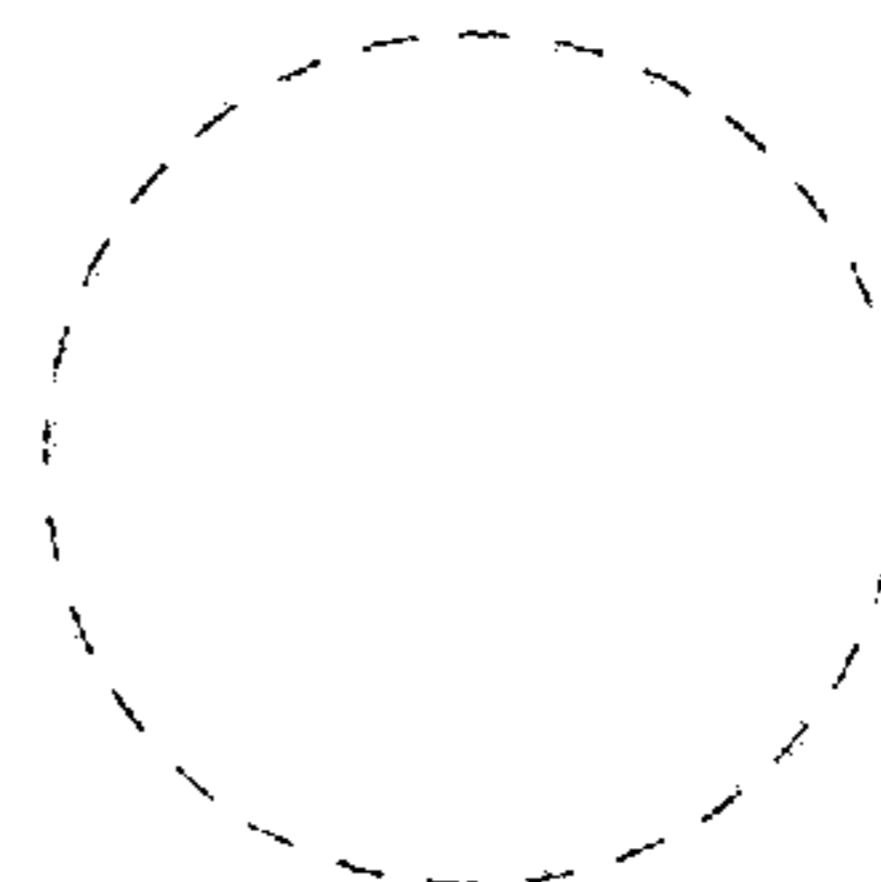

FIG. 33

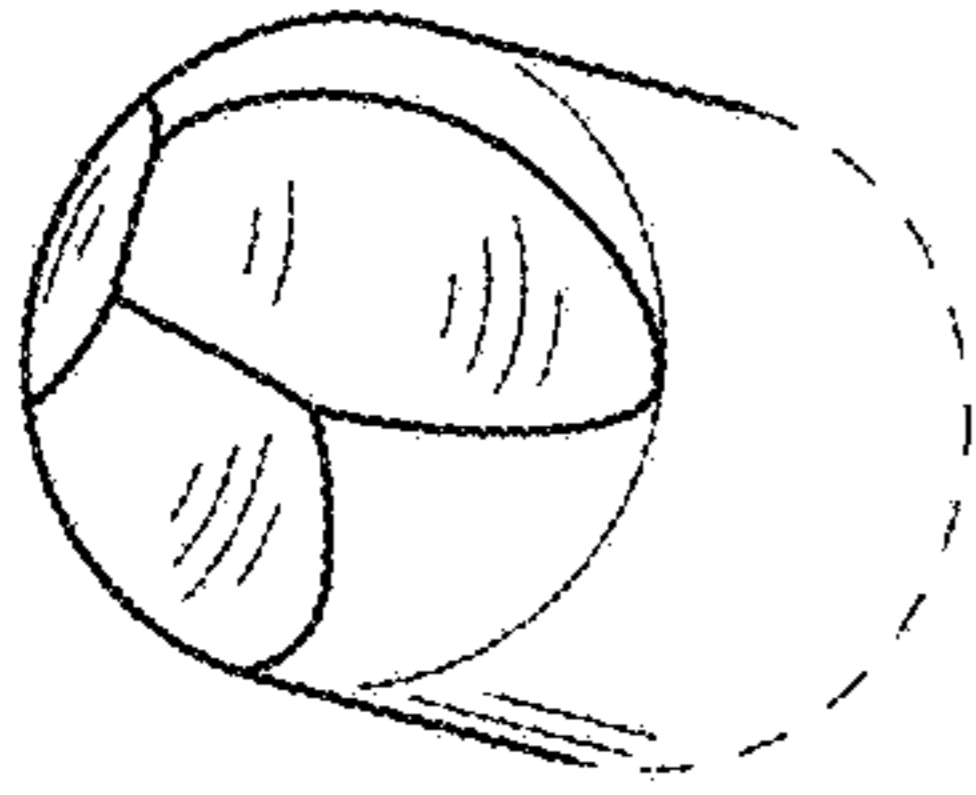

FIG. 34

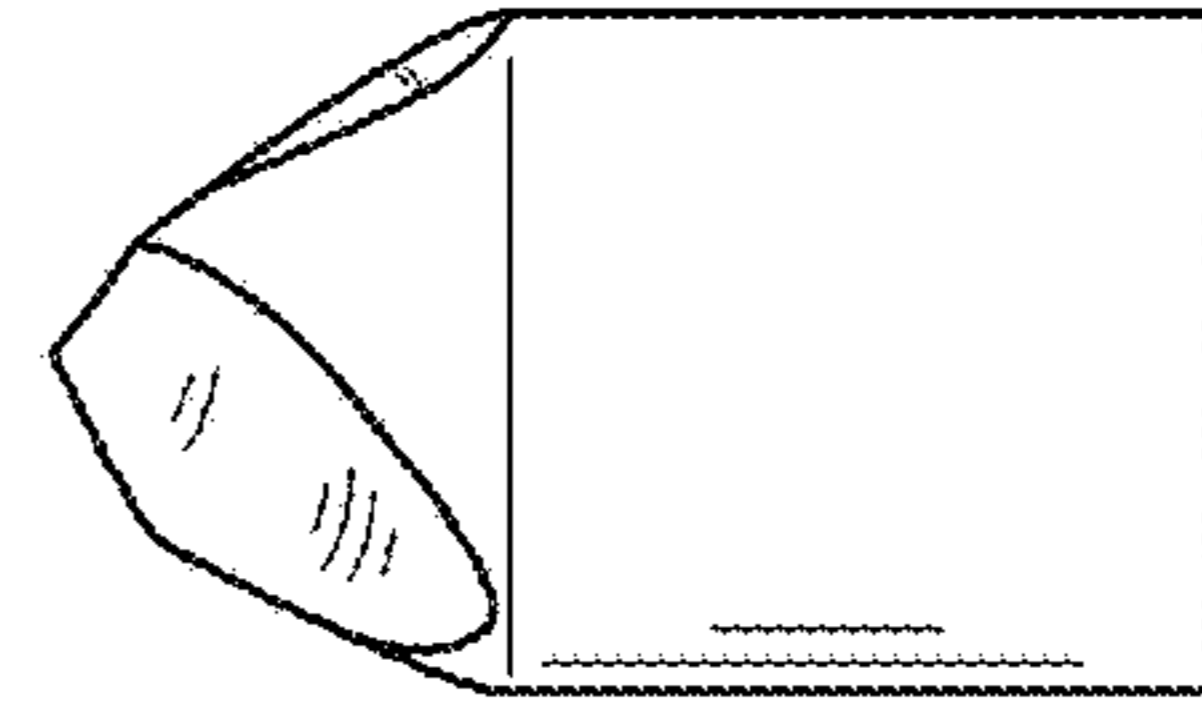

FIG. 35

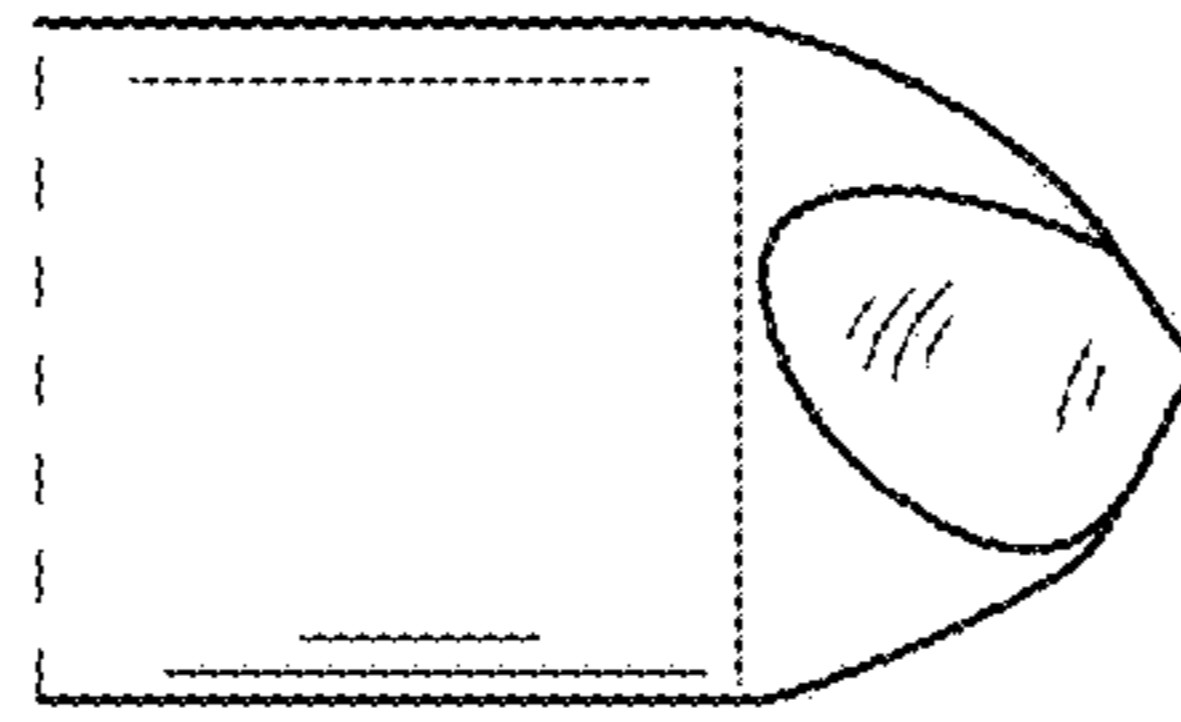

FIG. 36

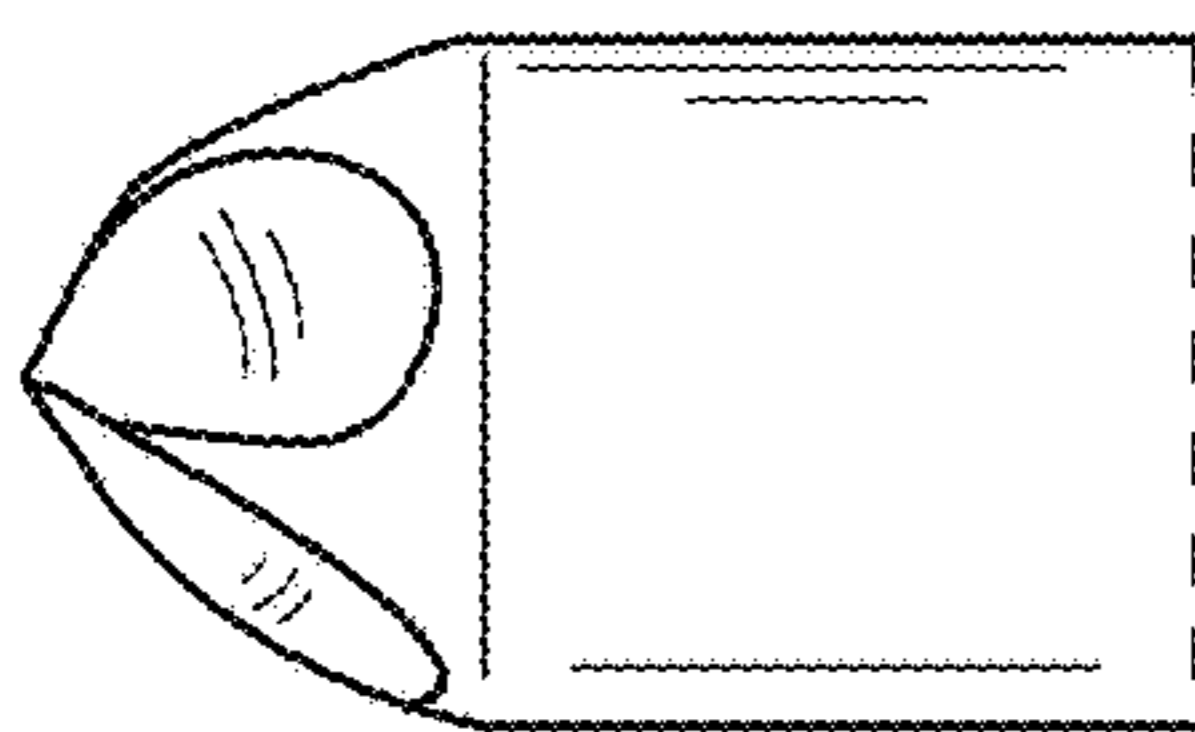

FIG. 37

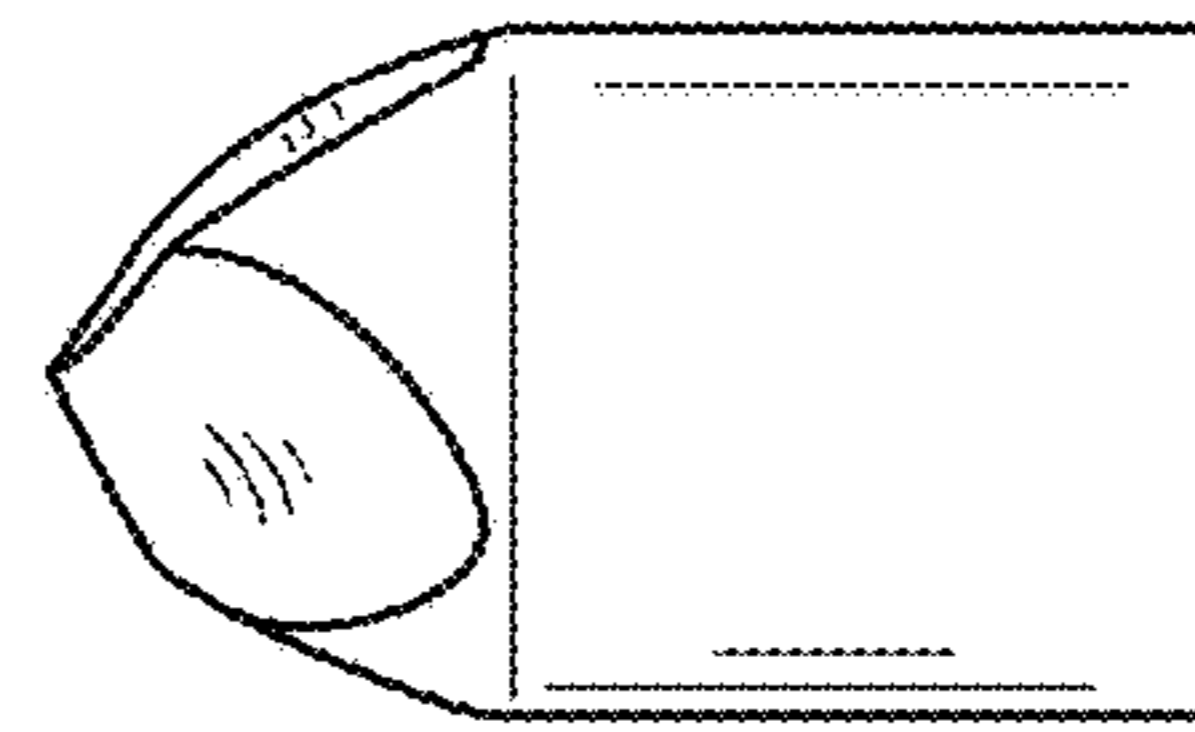

FIG. 38

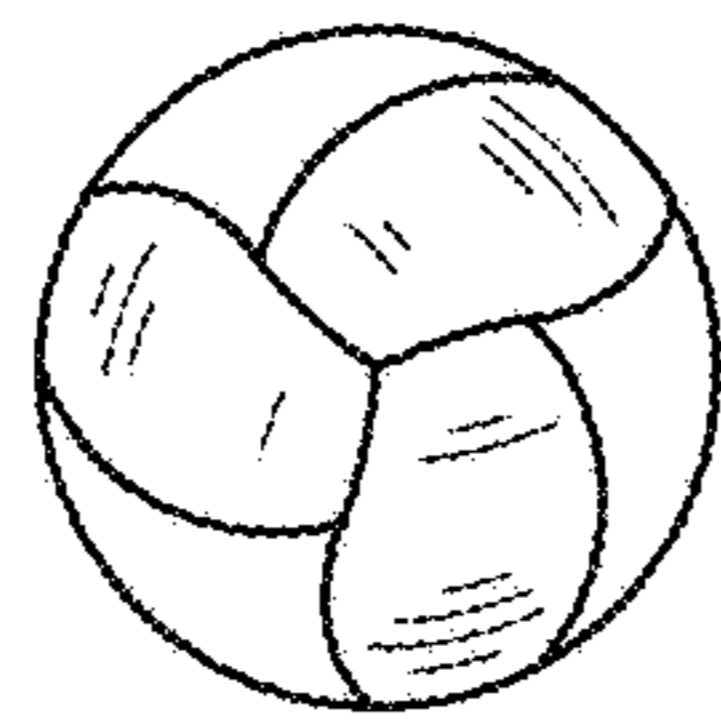

FIG. 39

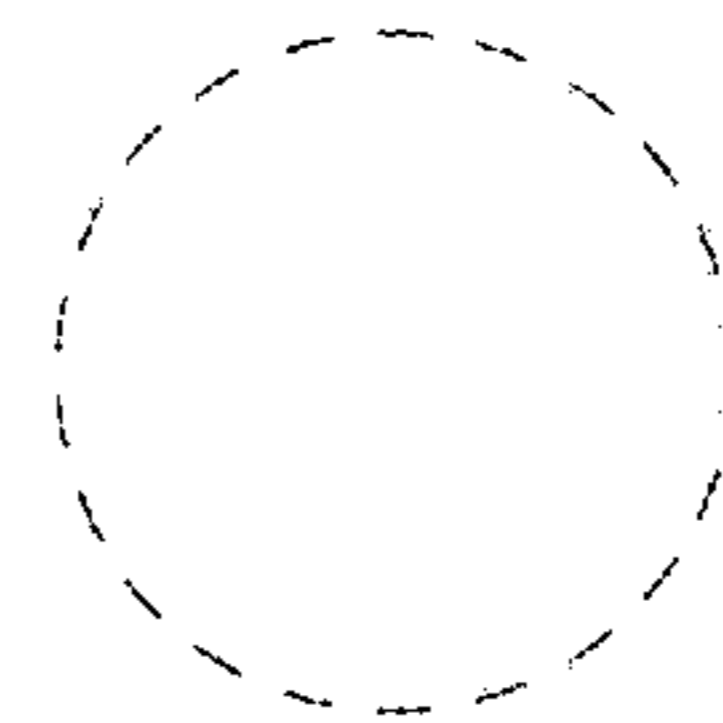

FIG. 40

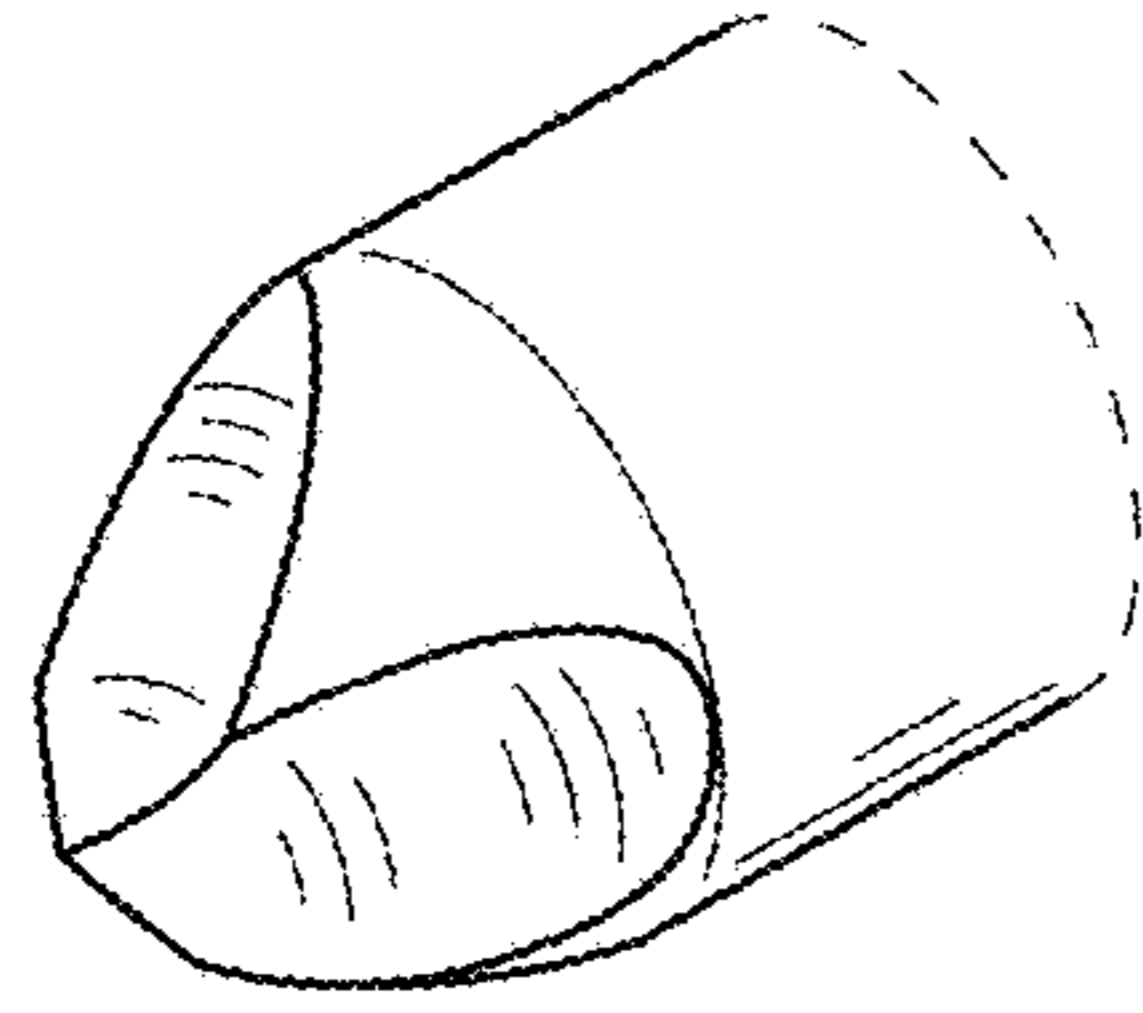

FIG. 41

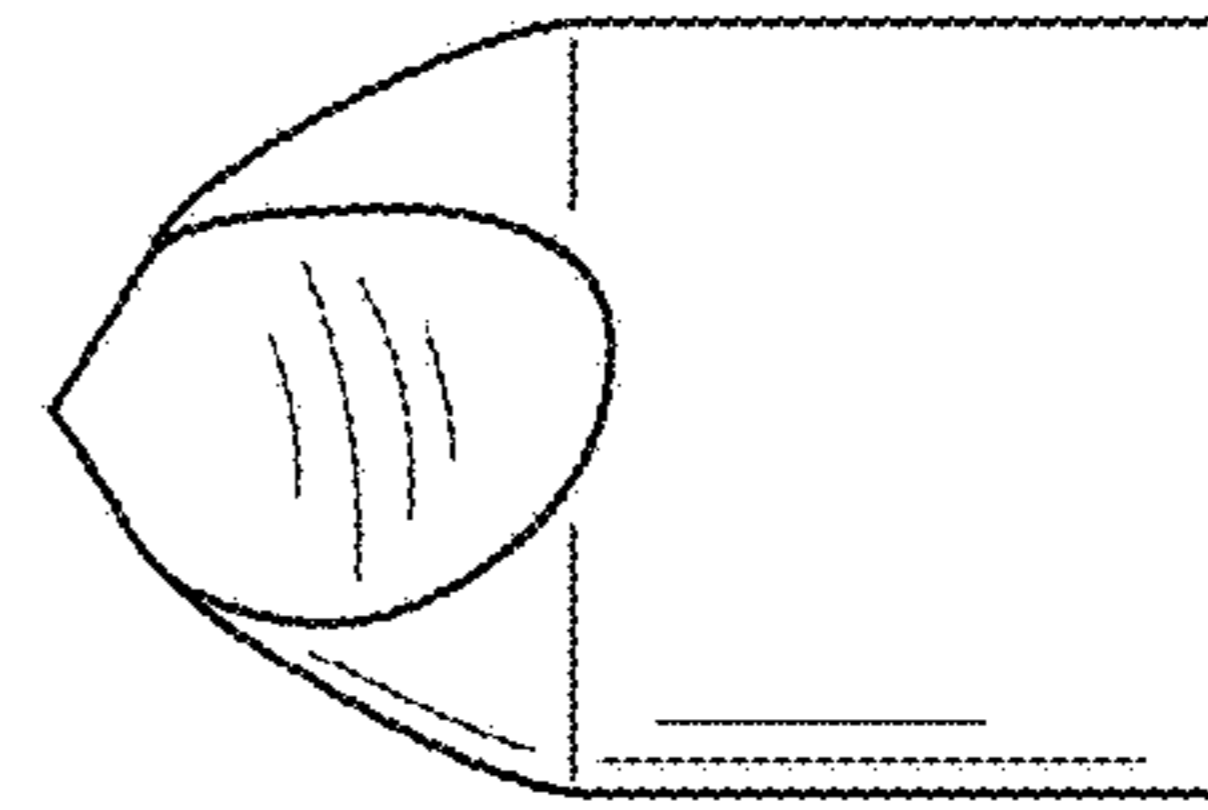

FIG. 42

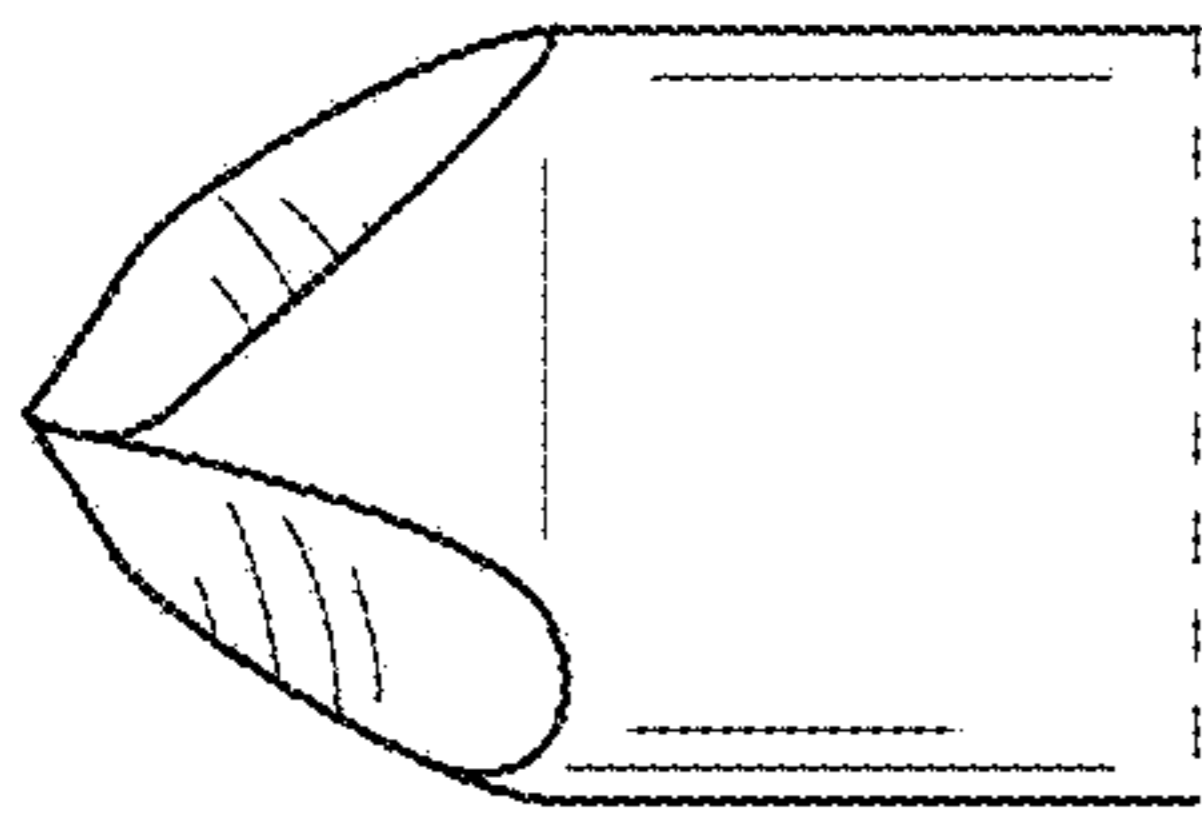

FIG. 43

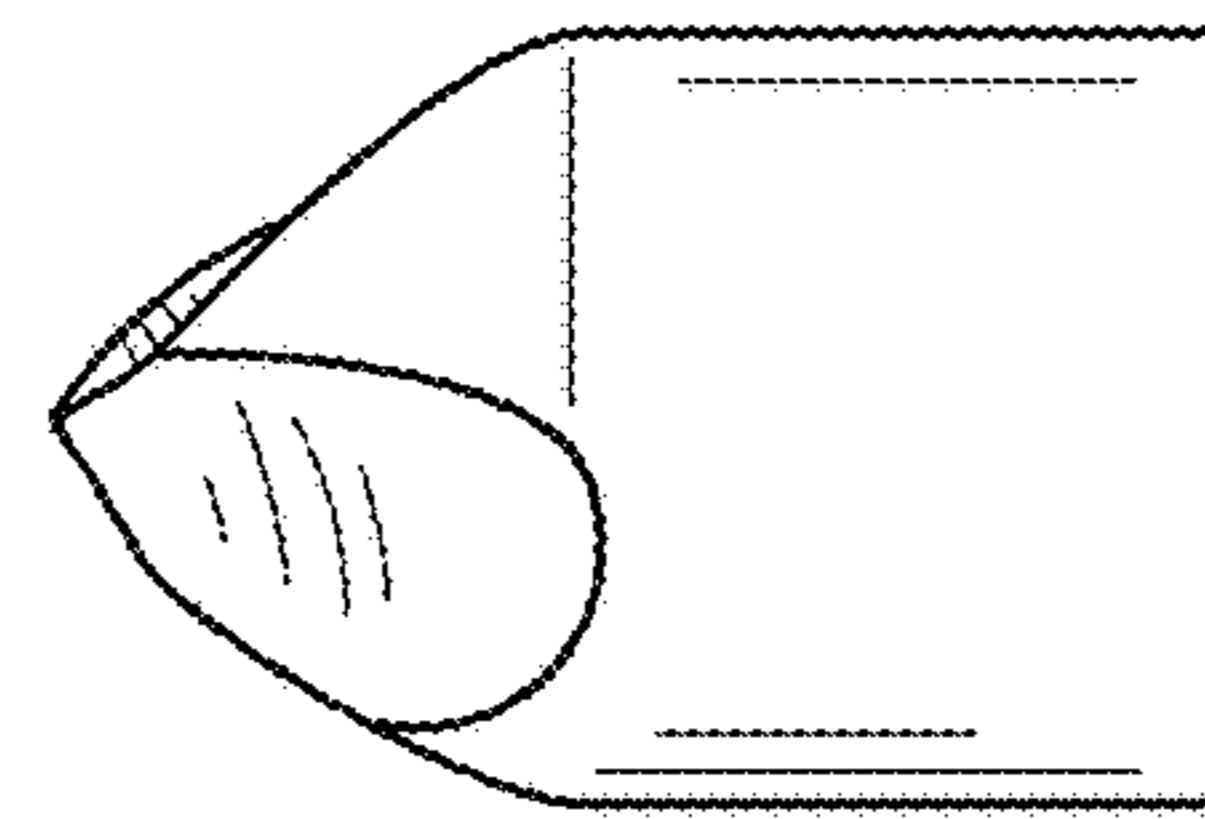

FIG. 44

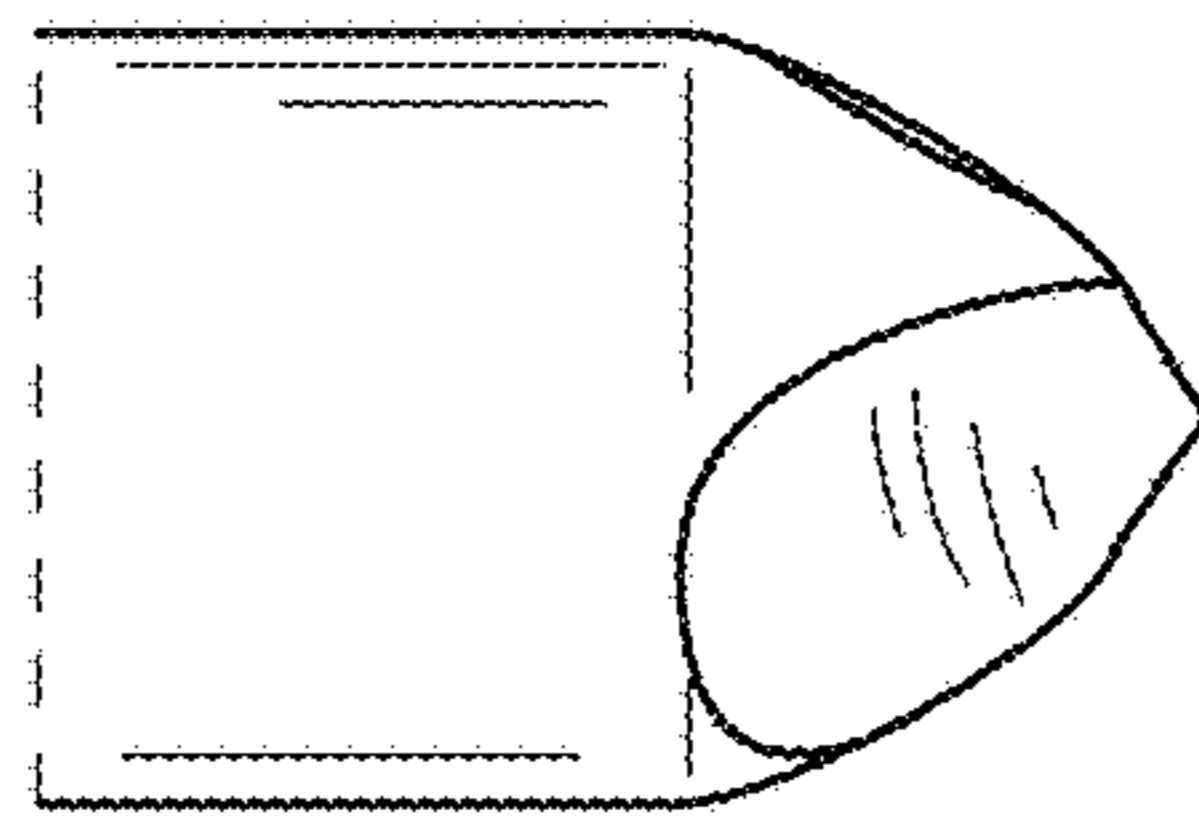

FIG. 45

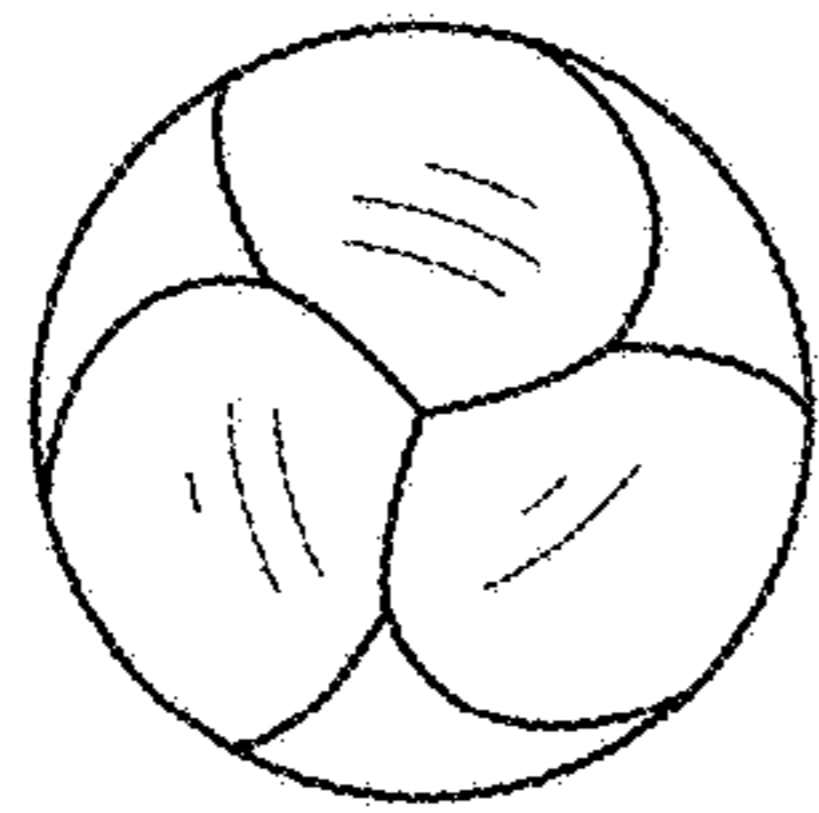

FIG. 46

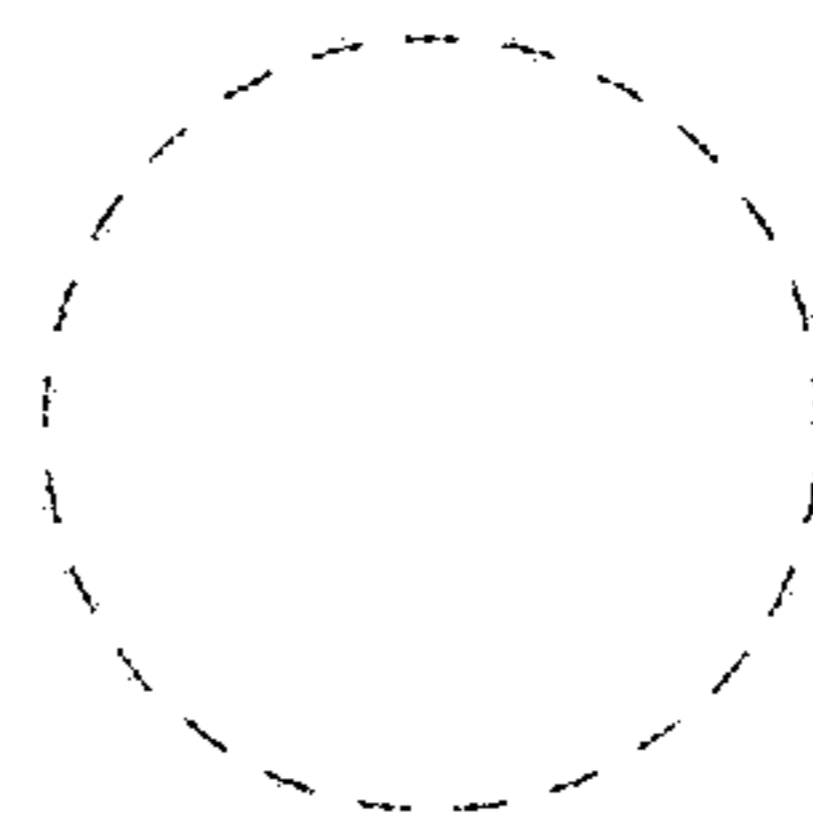

FIG. 47

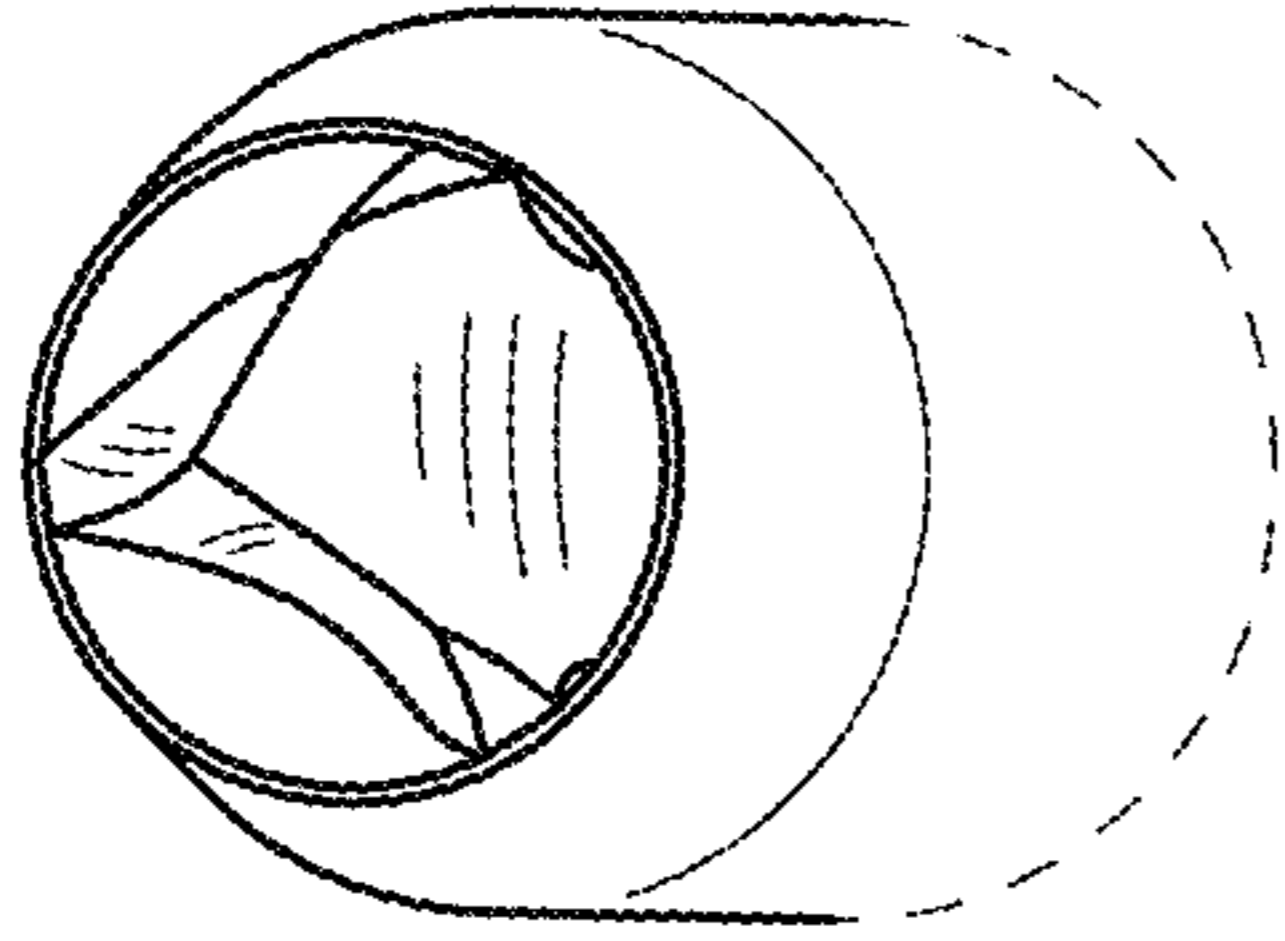

FIG. 48

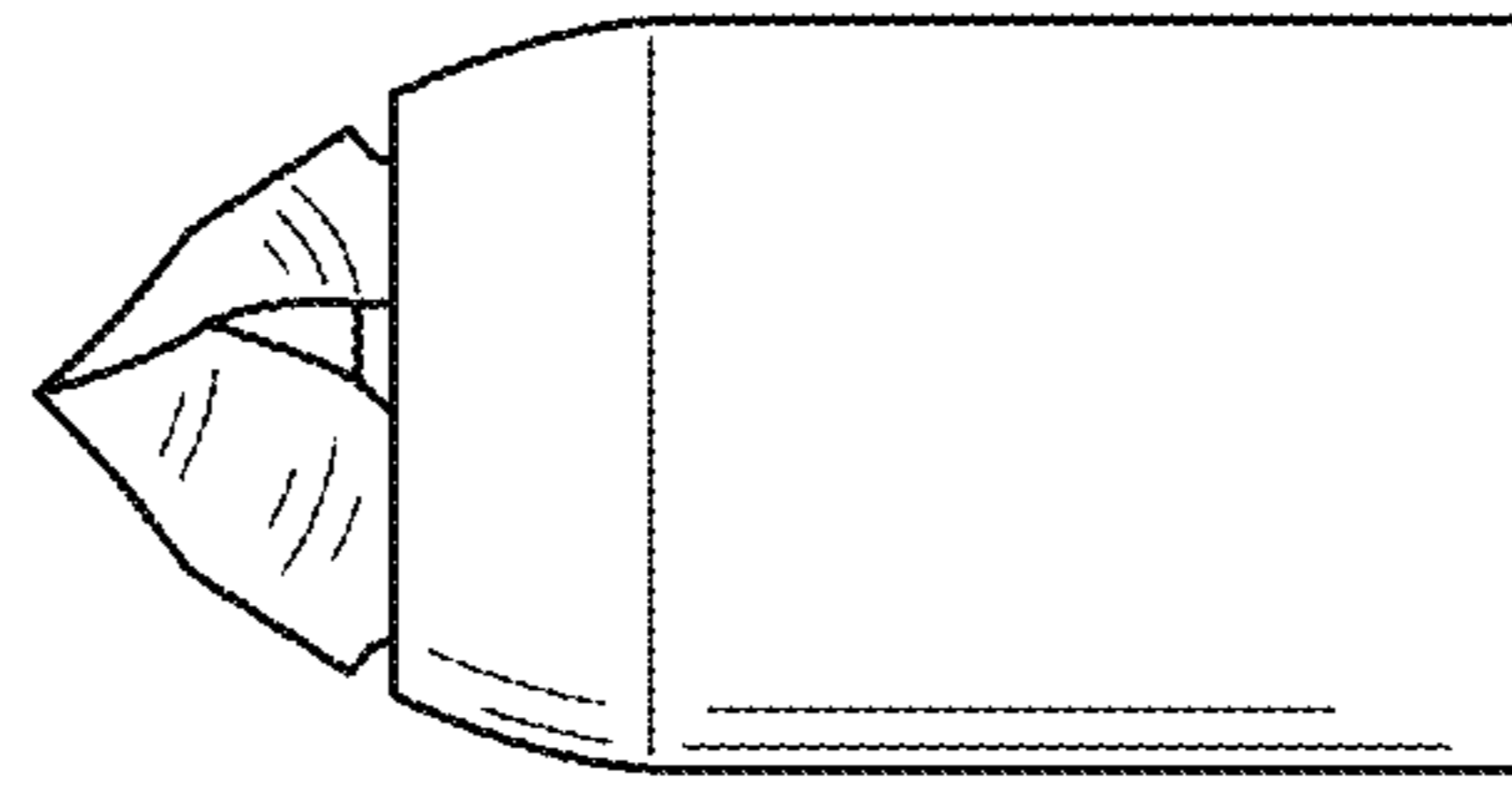

FIG. 49

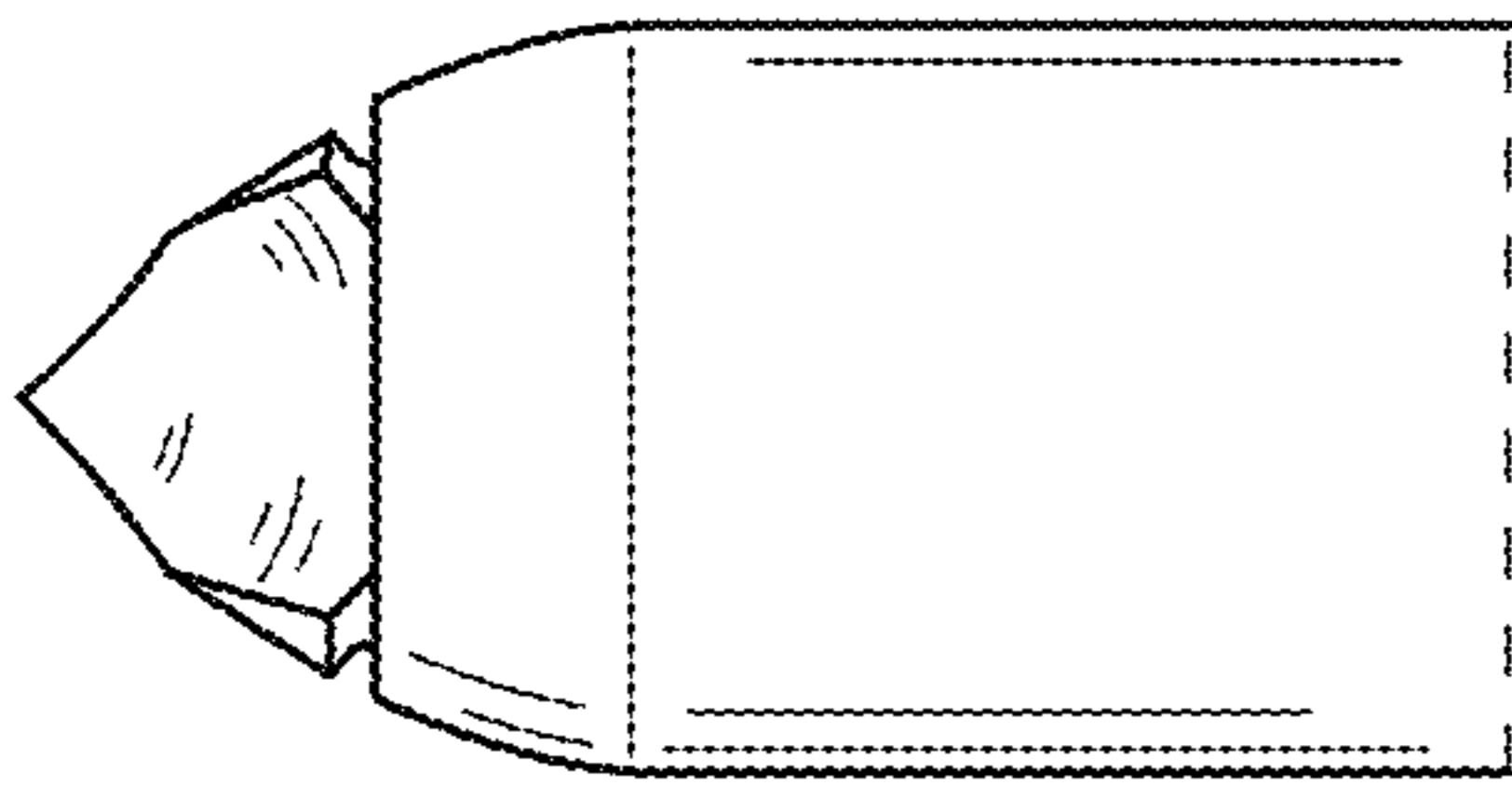

FIG. 50

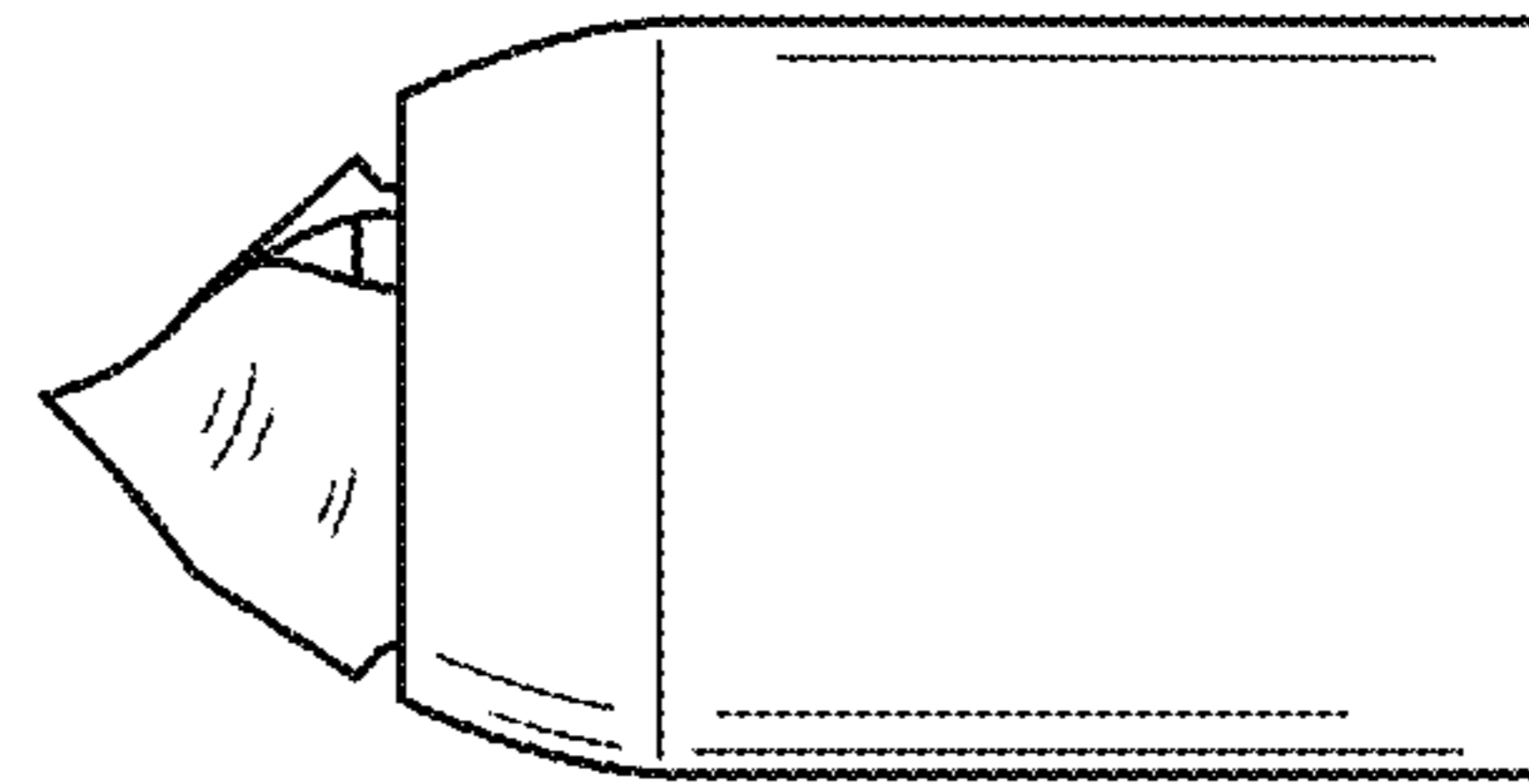

FIG. 51

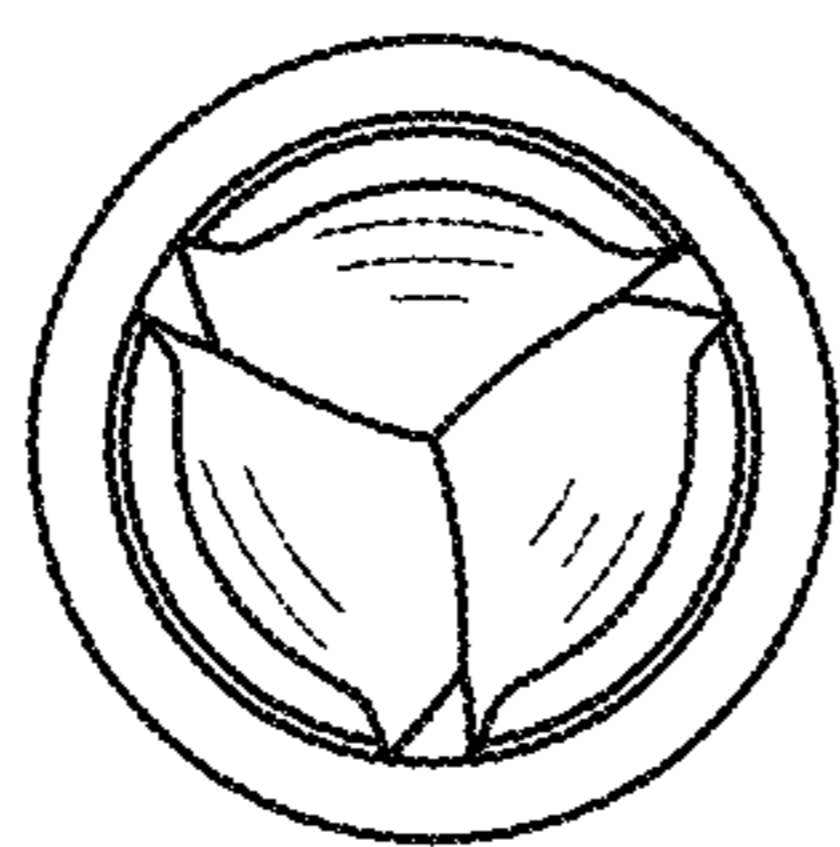

FIG. 52

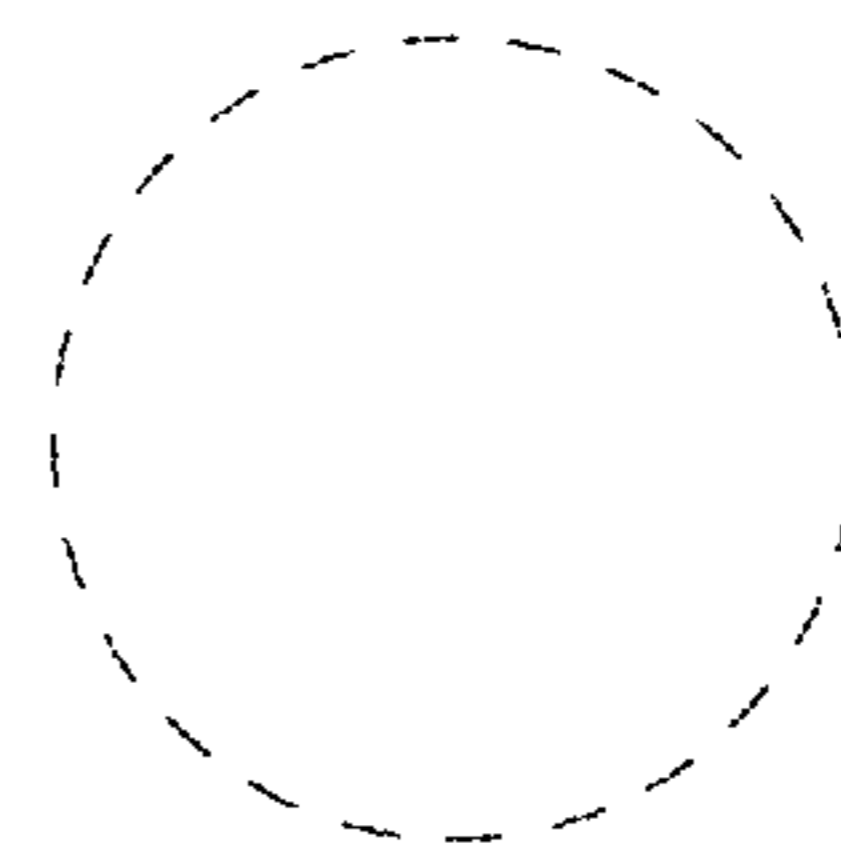

FIG. 53

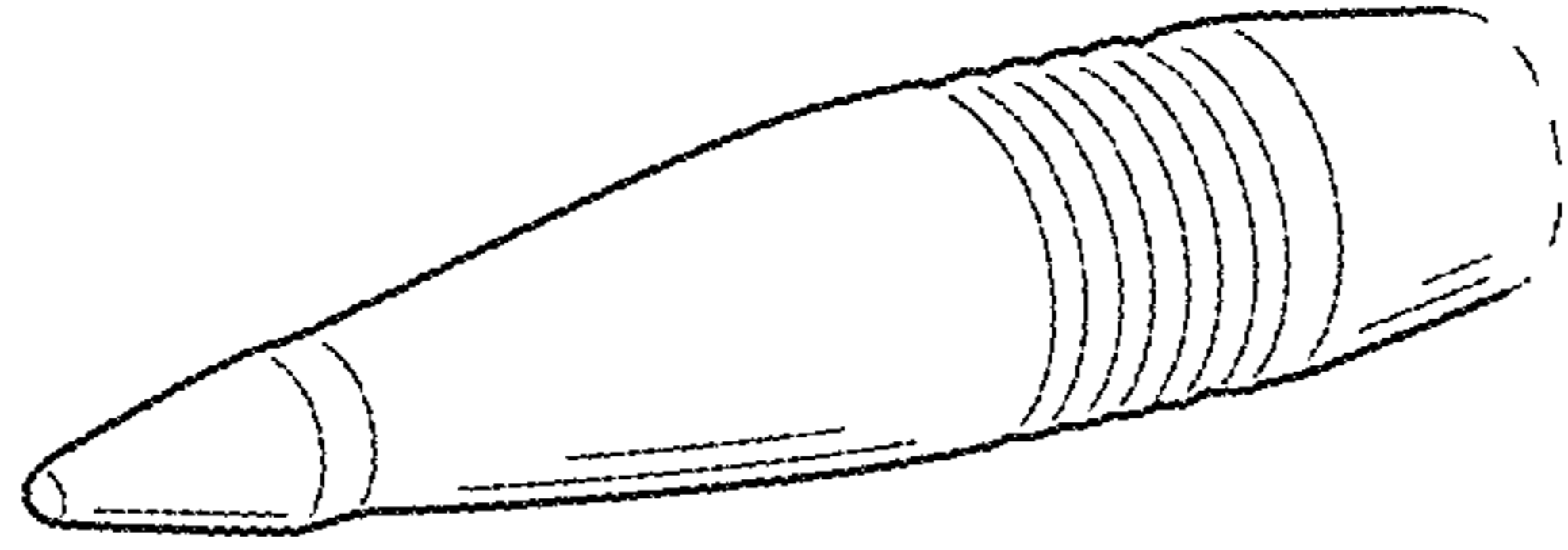

FIG. 54

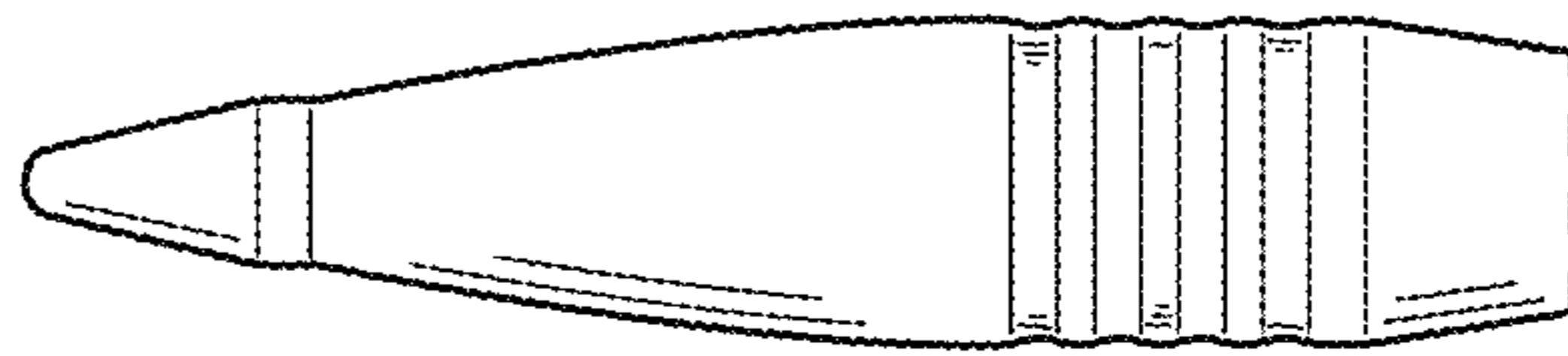

FIG. 55

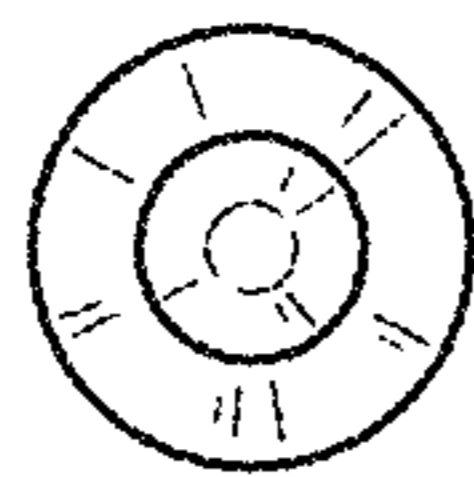

FIG. 56

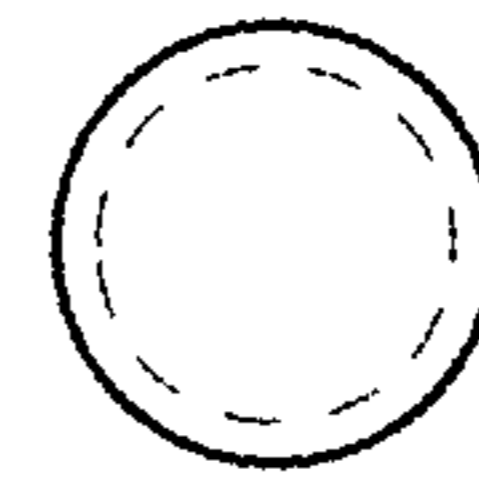

FIG. 57

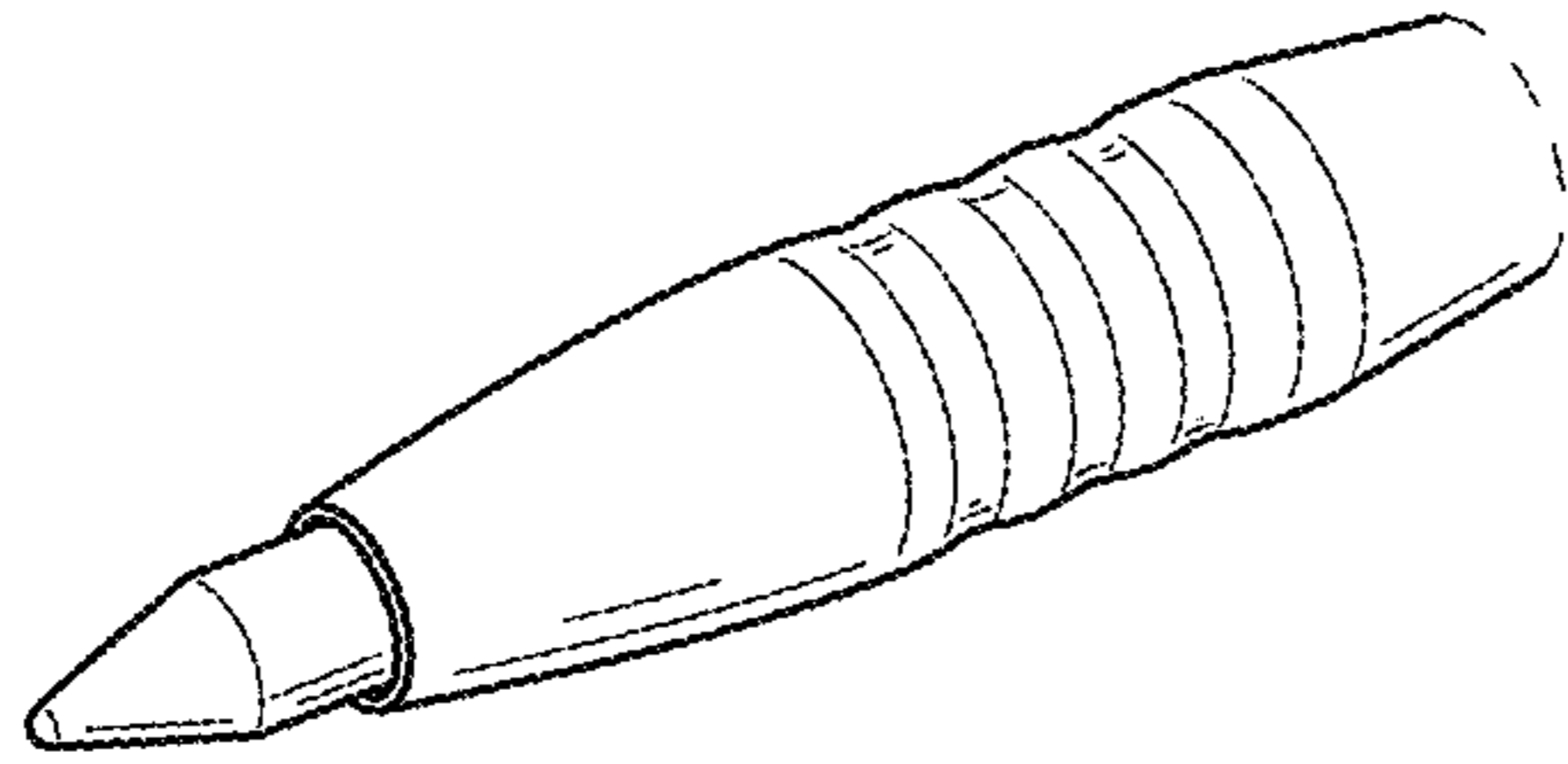

FIG.58

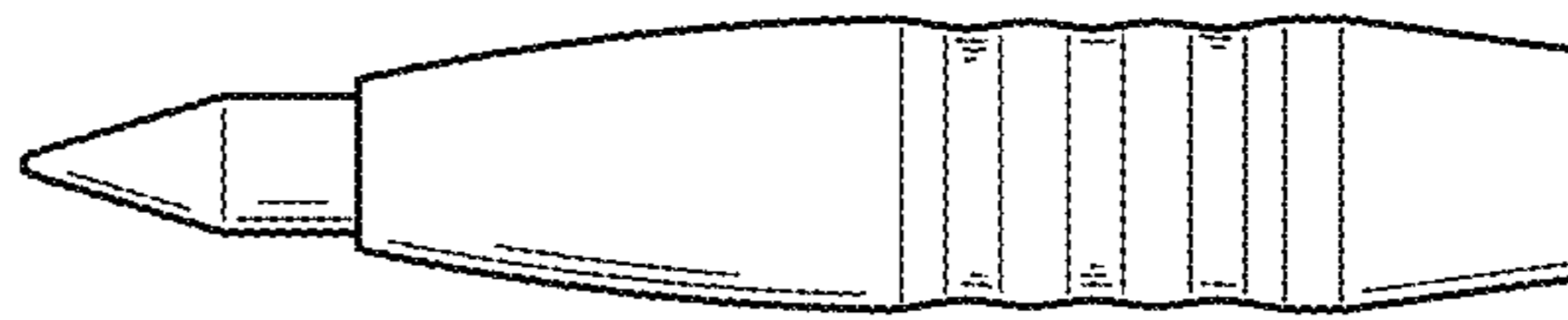

FIG.59

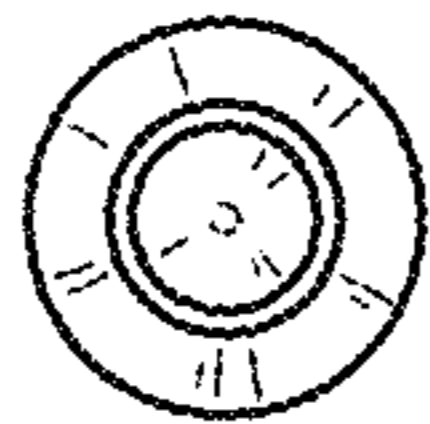

FIG.60

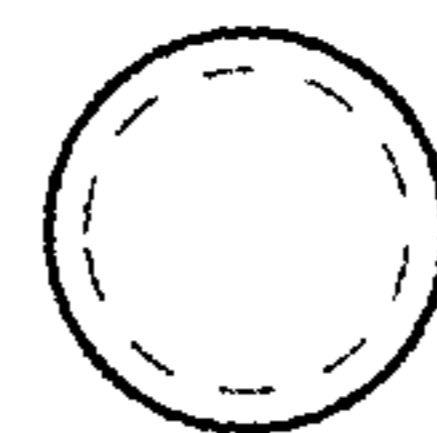

FIG.61

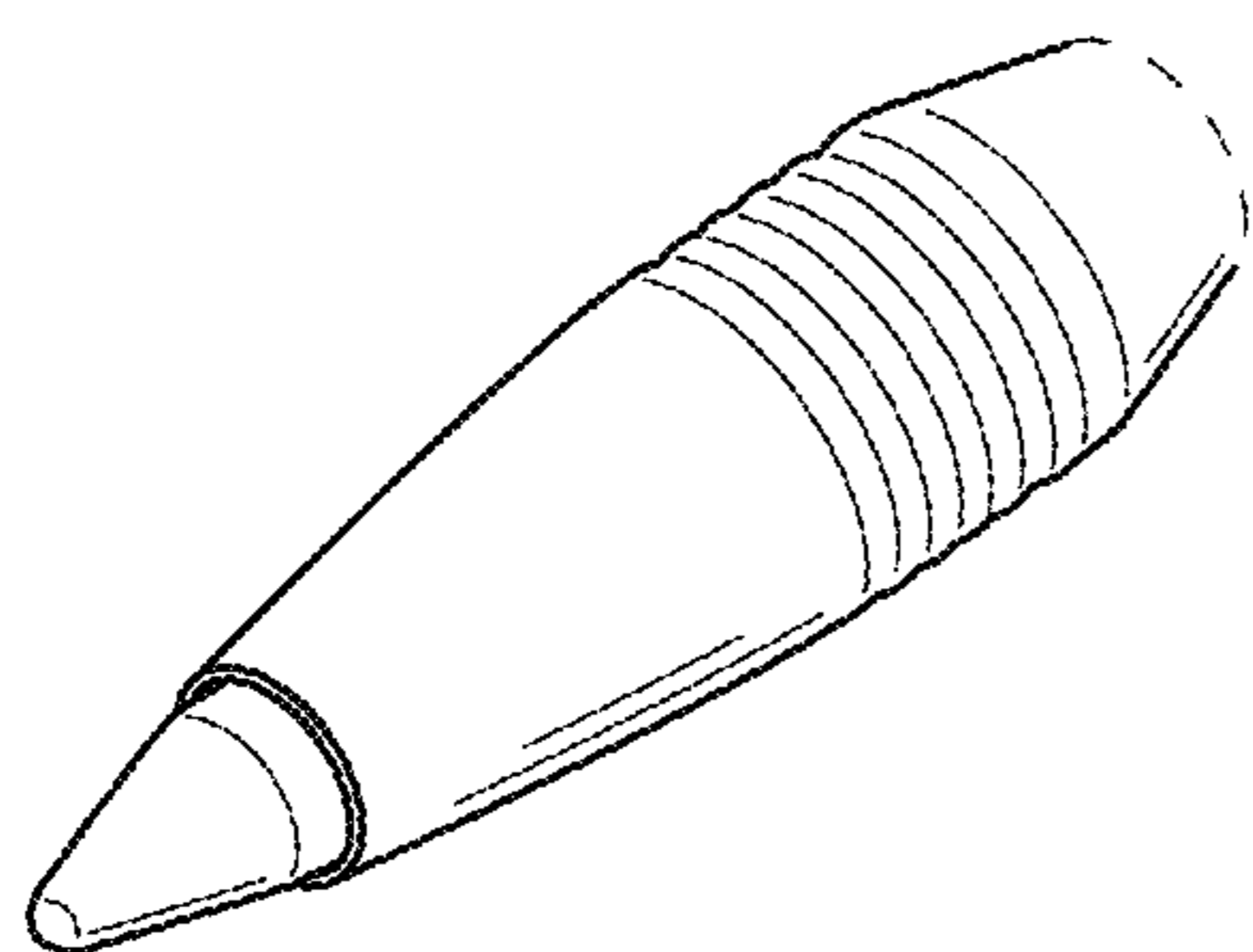

FIG. 62

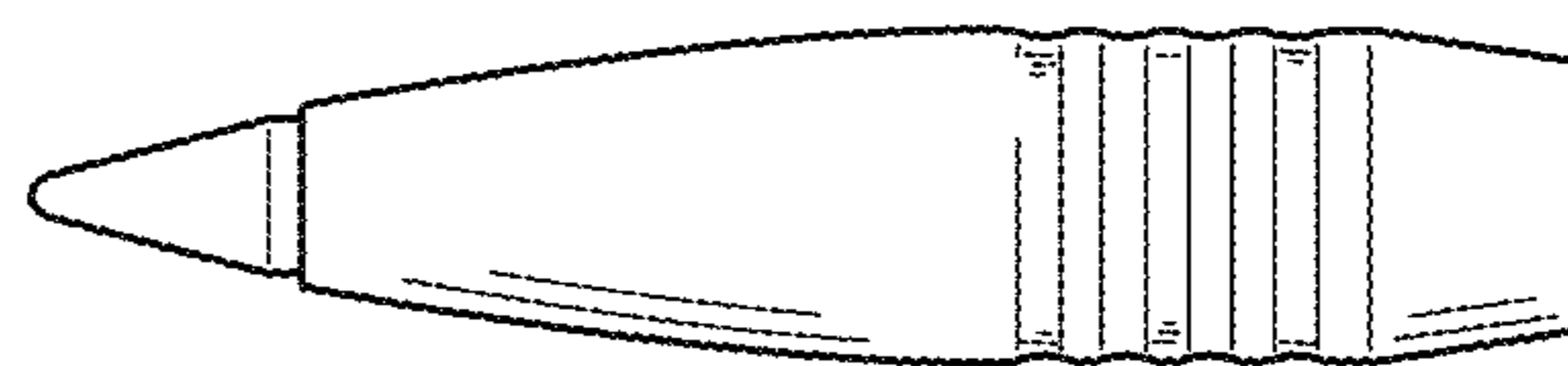

FIG. 63

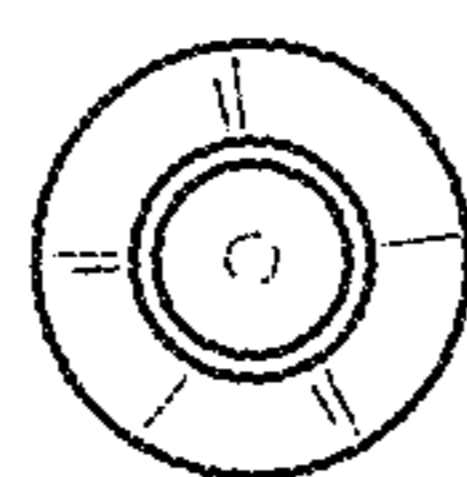

FIG. 64

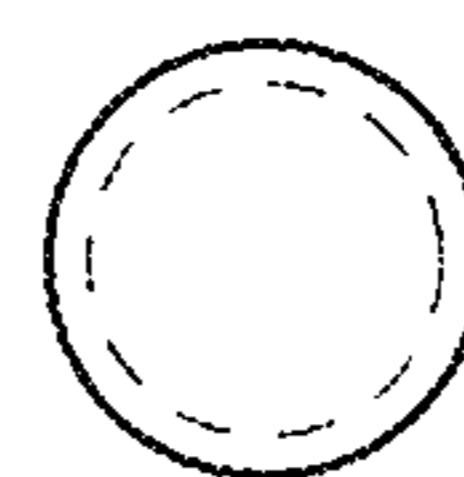

FIG. 65

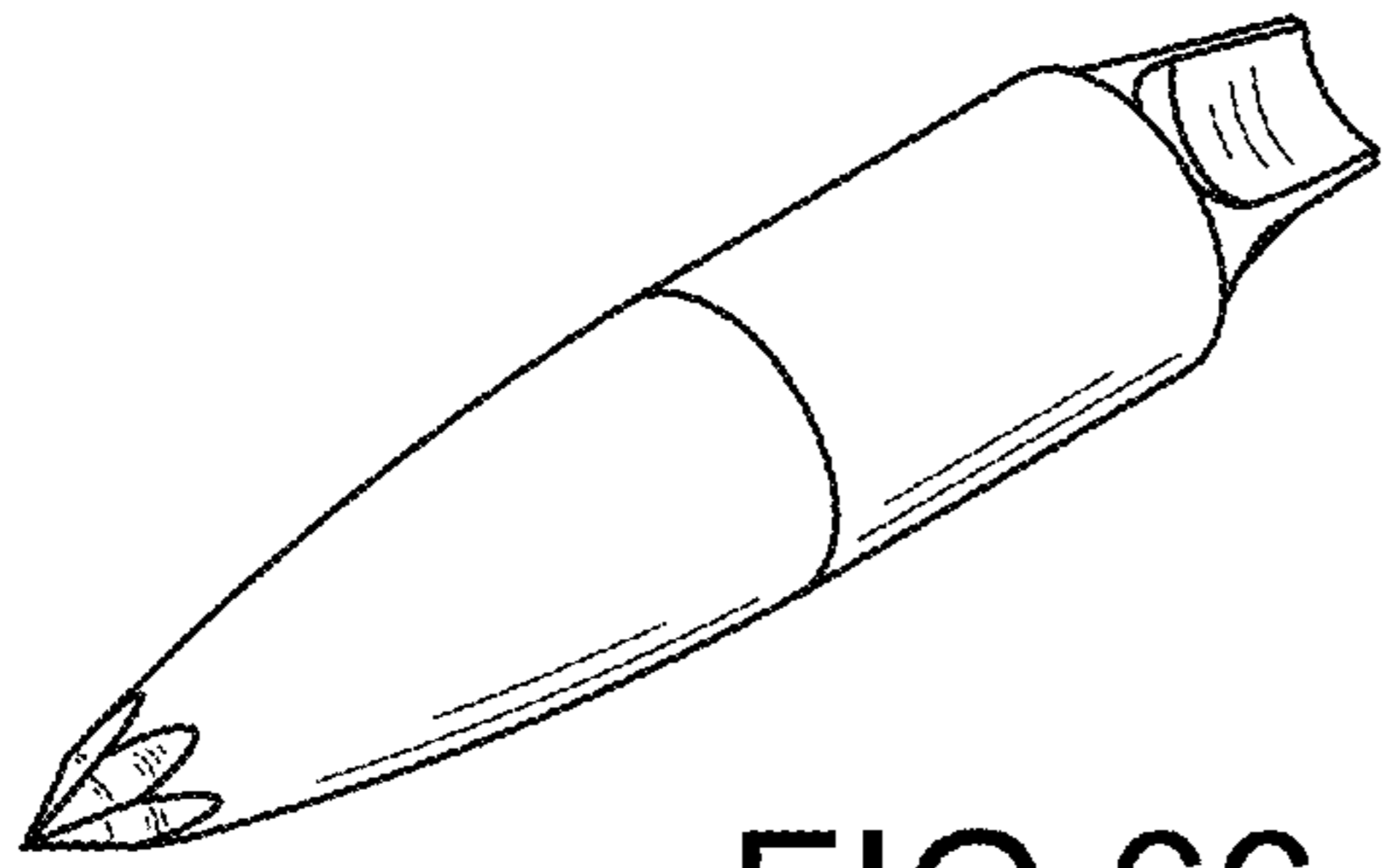

FIG. 66

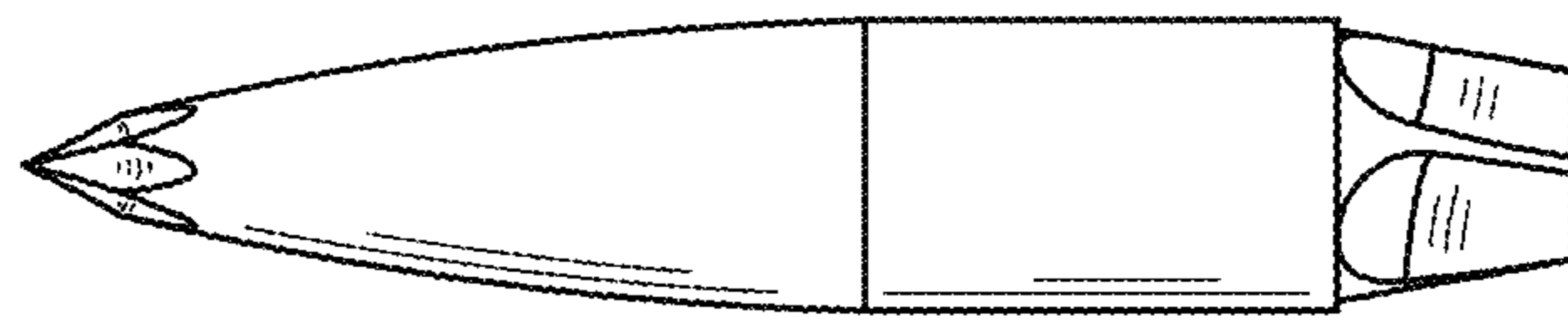

FIG. 67

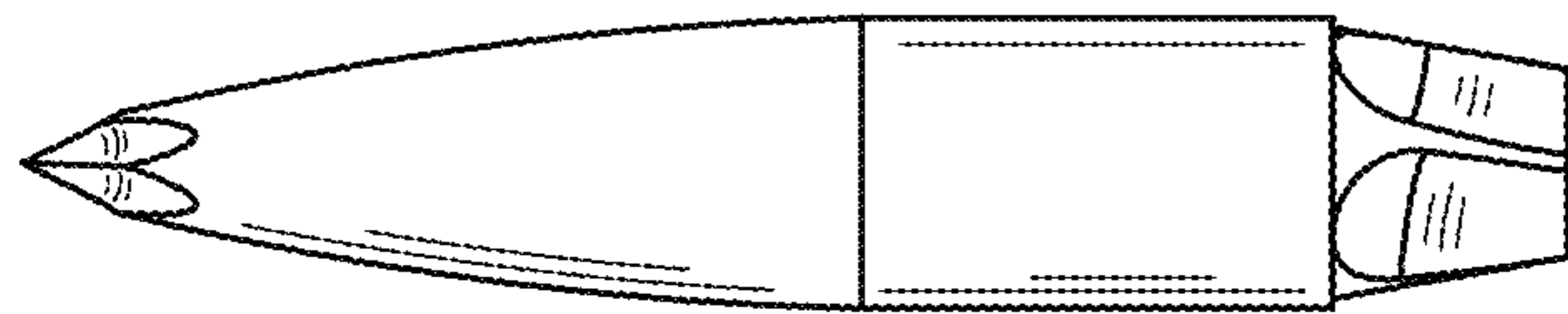

FIG. 68

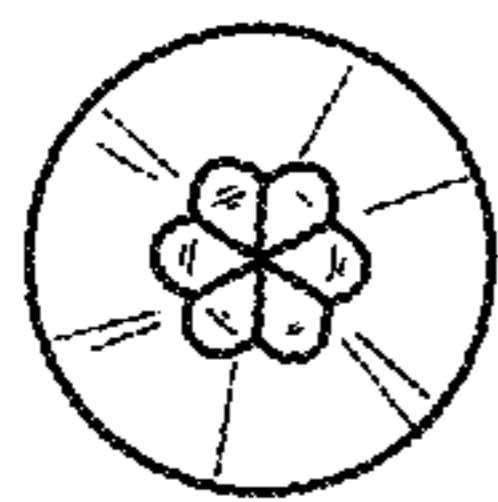

FIG. 69

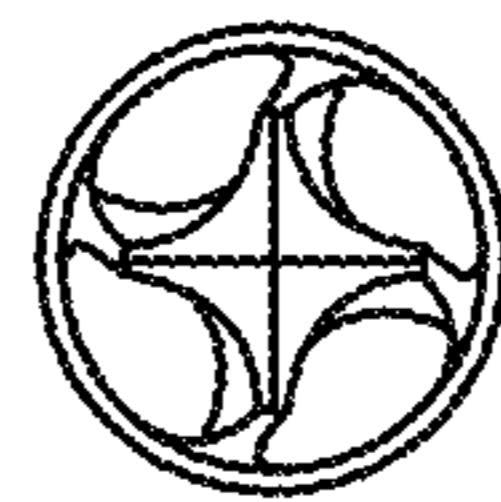

FIG. 70

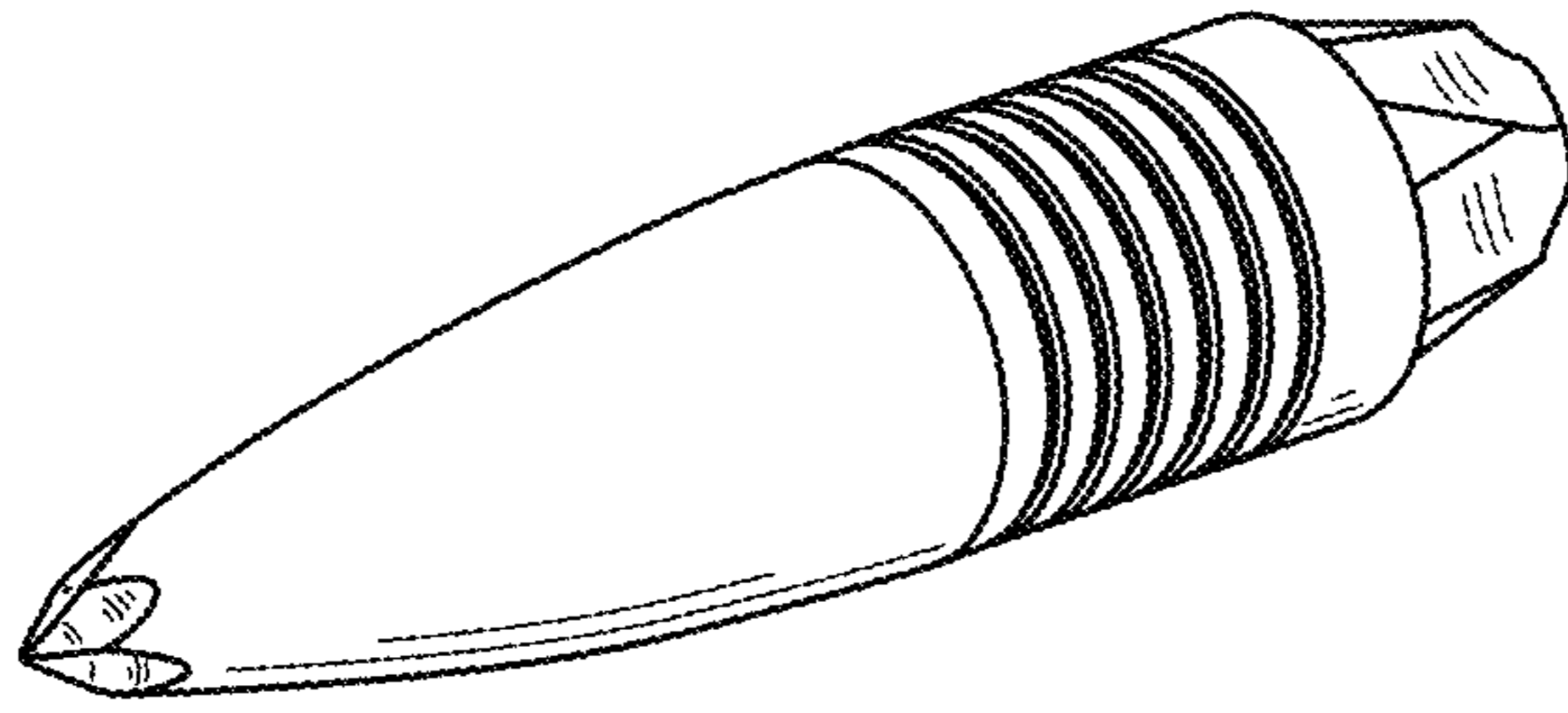

FIG. 71

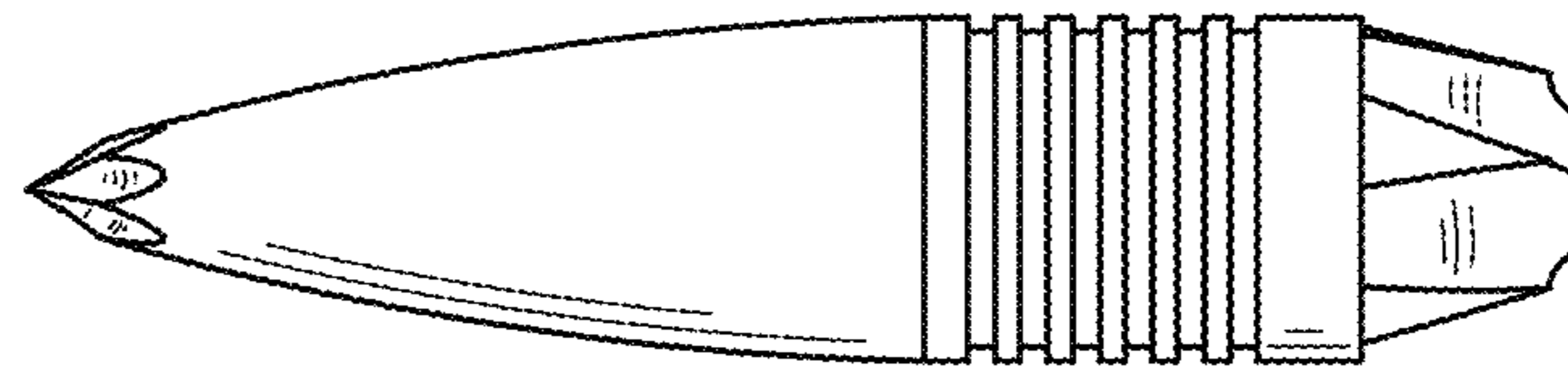

FIG. 72

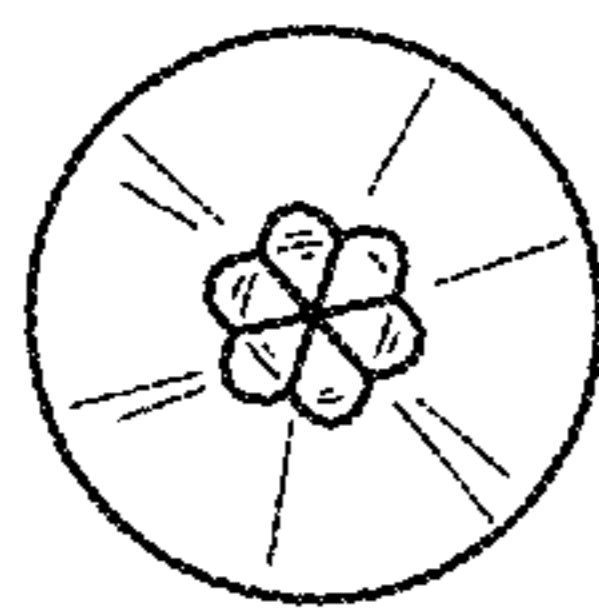

FIG. 73