

US00D691688S

(12) **United States Design Patent**
Pescovitz

(10) **Patent No.:** **US D691,688 S**

(45) **Date of Patent:** **** Oct. 15, 2013**

(54) **PERSONAL ENCLOSURE**

(76) **Inventor:** **Eric Frank Pescovitz**, Cincinnati, OH
(US)

(**) **Term:** **14 Years**

(21) **Appl. No.:** **29/388,538**

(22) **Filed:** **Mar. 30, 2011**

(51) **LOC (9) Cl.** **21-04**

(52) **U.S. Cl.**
USPC **D21/838**

(58) **Field of Classification Search**
USPC D21/834-838; D25/16; D32/36,
D32/37; D3/305; 135/115, 123-126, 128,
135/135-137, 143, 900, 902
See application file for complete search history.

6,453,923	B2 *	9/2002	Zheng	135/126
6,851,439	B2 *	2/2005	Zheng	135/126
D511,196	S	11/2005	Wehner		
D514,747	S *	2/2006	Bertoli et al.	D30/108
7,040,333	B1 *	5/2006	Ransom et al.	135/126
7,137,399	B1 *	11/2006	Ransom et al.	135/128
7,201,177	B2 *	4/2007	Anticoli et al.	135/125
D559,140	S *	1/2008	Hilton	D10/113.4
7,484,520	B2	2/2009	Zheng		
D610,217	S *	2/2010	Krueger	D21/836
D617,838	S *	6/2010	Jedlicka	D20/10
D617,841	S *	6/2010	Jedlicka	D20/10
2004/0159347	A1	8/2004	Brown et al.		
2005/0081903	A1 *	4/2005	Wang	135/126

* cited by examiner

Primary Examiner — Cynthia M Chin
(74) *Attorney, Agent, or Firm* — Taft Stettinius & Hollister
LLP

(56) **References Cited**

U.S. PATENT DOCUMENTS

D237,964	S	12/1975	Choponis		
D250,687	S	1/1979	Robelen		
4,582,062	A	4/1986	Albini		
D285,880	S	9/1986	Griesenbeck		
4,719,935	A	1/1988	Gustafson		
D313,830	S	1/1991	Foust		
5,080,119	A	1/1992	Scherer		
D326,495	S	5/1992	Pearce		
D366,305	S	1/1996	Roehler		
D381,058	S	7/1997	Lowenthal		
D383,188	S	9/1997	Bohart		
D412,959	S	8/1999	Cung		
D421,285	S	2/2000	Murphy		
6,071,174	A	6/2000	Yoon		
6,092,544	A	7/2000	Zheng		
D429,307	S	8/2000	Wu et al.		
6,305,396	B1 *	10/2001	Zheng	135/126
6,318,394	B1	11/2001	Zheng		

(57) **CLAIM**

I claim the ornamental design for a personal enclosure, as shown and described.

DESCRIPTION

FIG. 1 is an elevated perspective view of a personal enclosure, showing my new design, from the left front;
FIG. 2 is a frontal view thereof;
FIG. 3 is a rear view thereof;
FIG. 4 is a left profile view thereof;
FIG. 5 is a right profile view thereof;
FIG. 6 is a top view thereof; and,
FIG. 7 is a bottom view thereof.
The broken lines shown are included for the purpose of illustrating the unclaimed portions of the article and form no part of the claimed design.

1 Claim, 4 Drawing Sheets

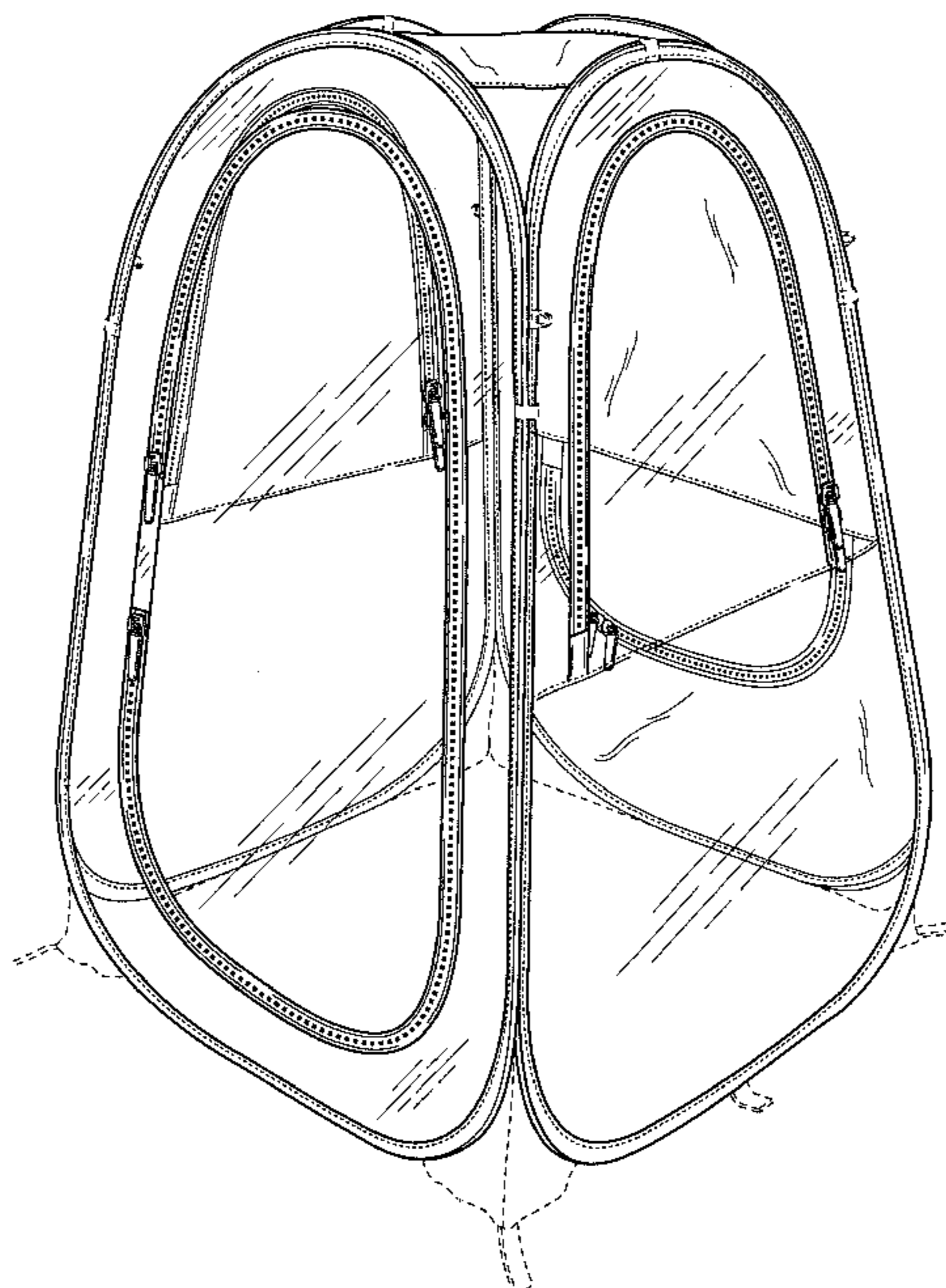

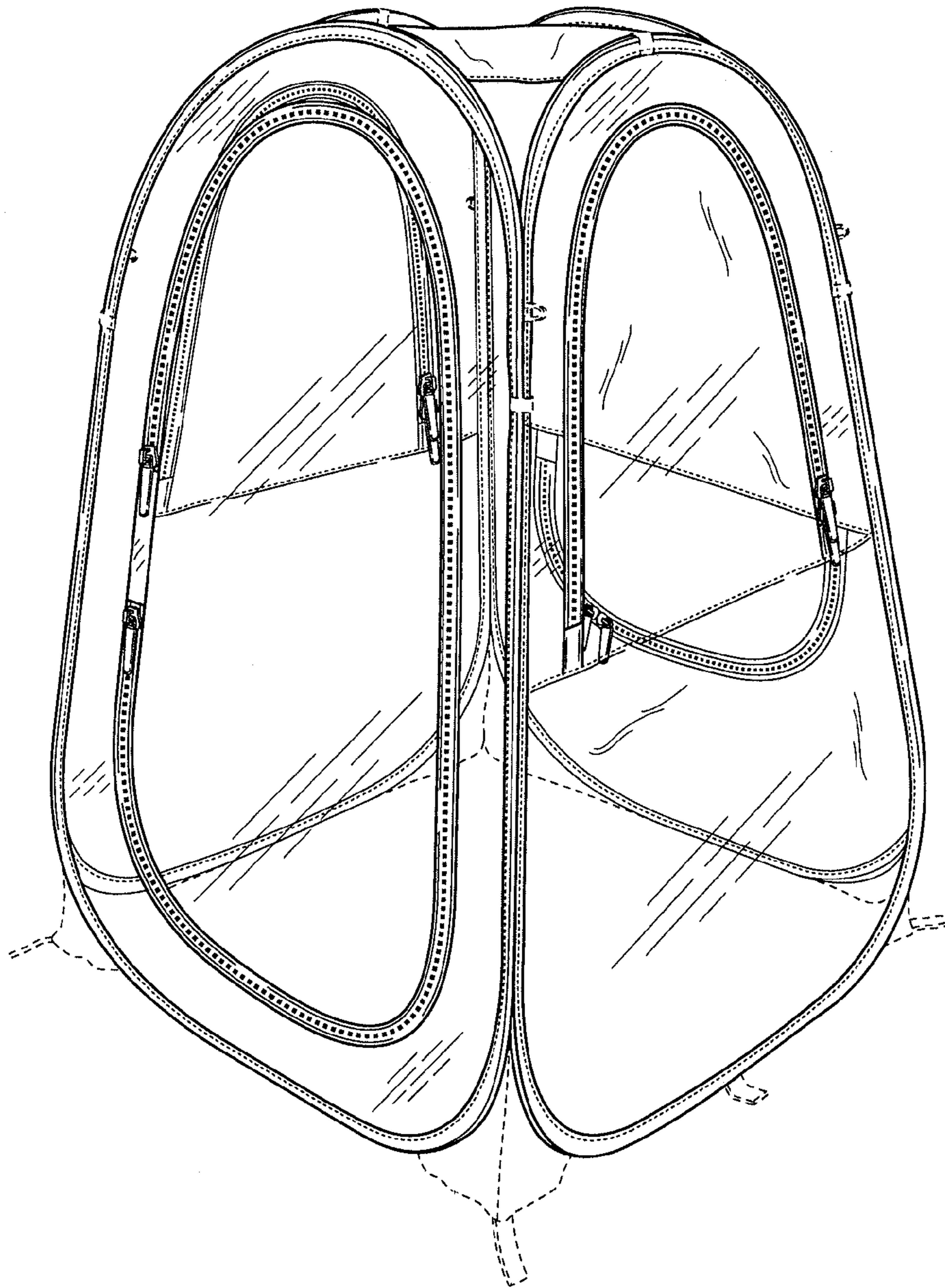

FIG. 1

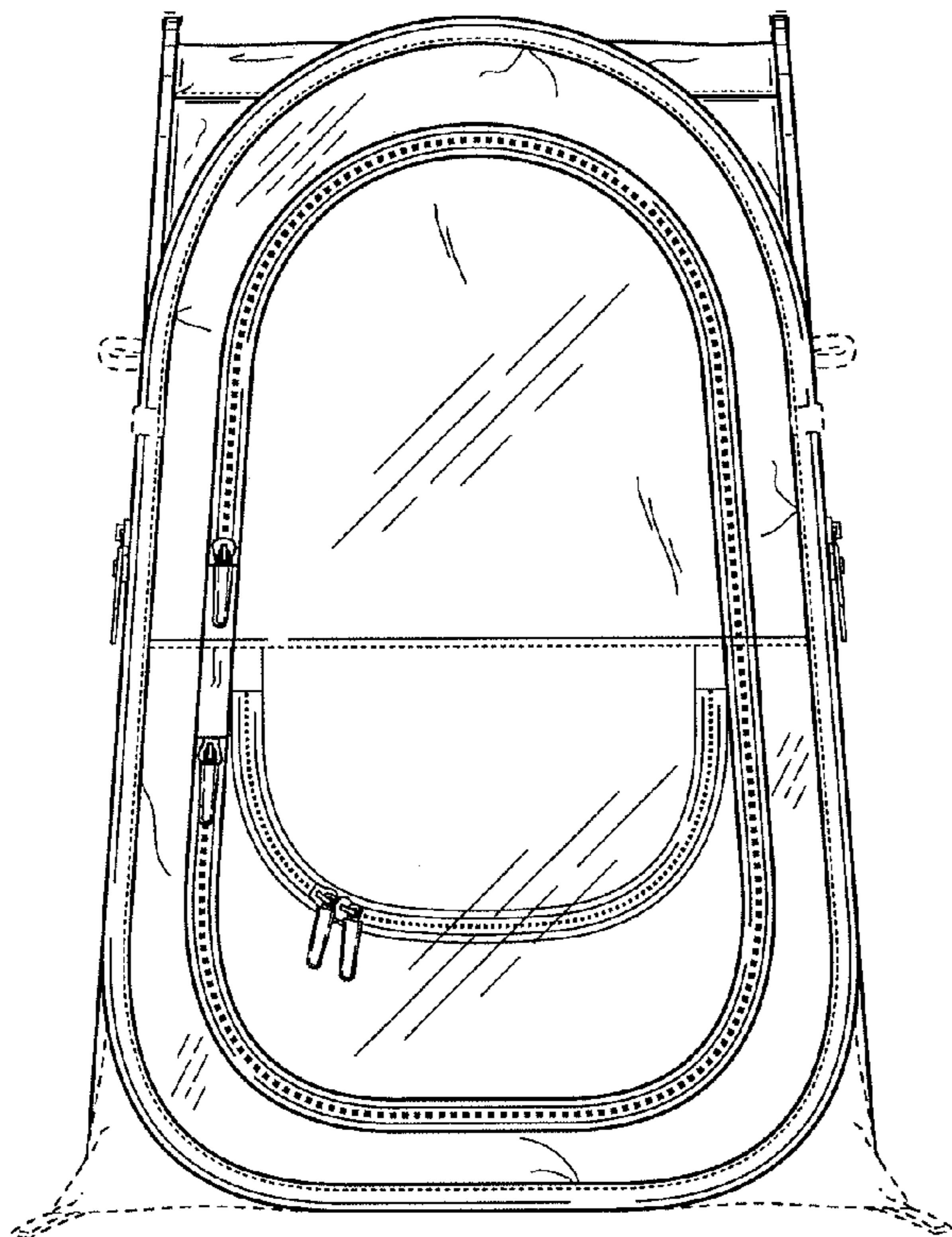

FIG. 2

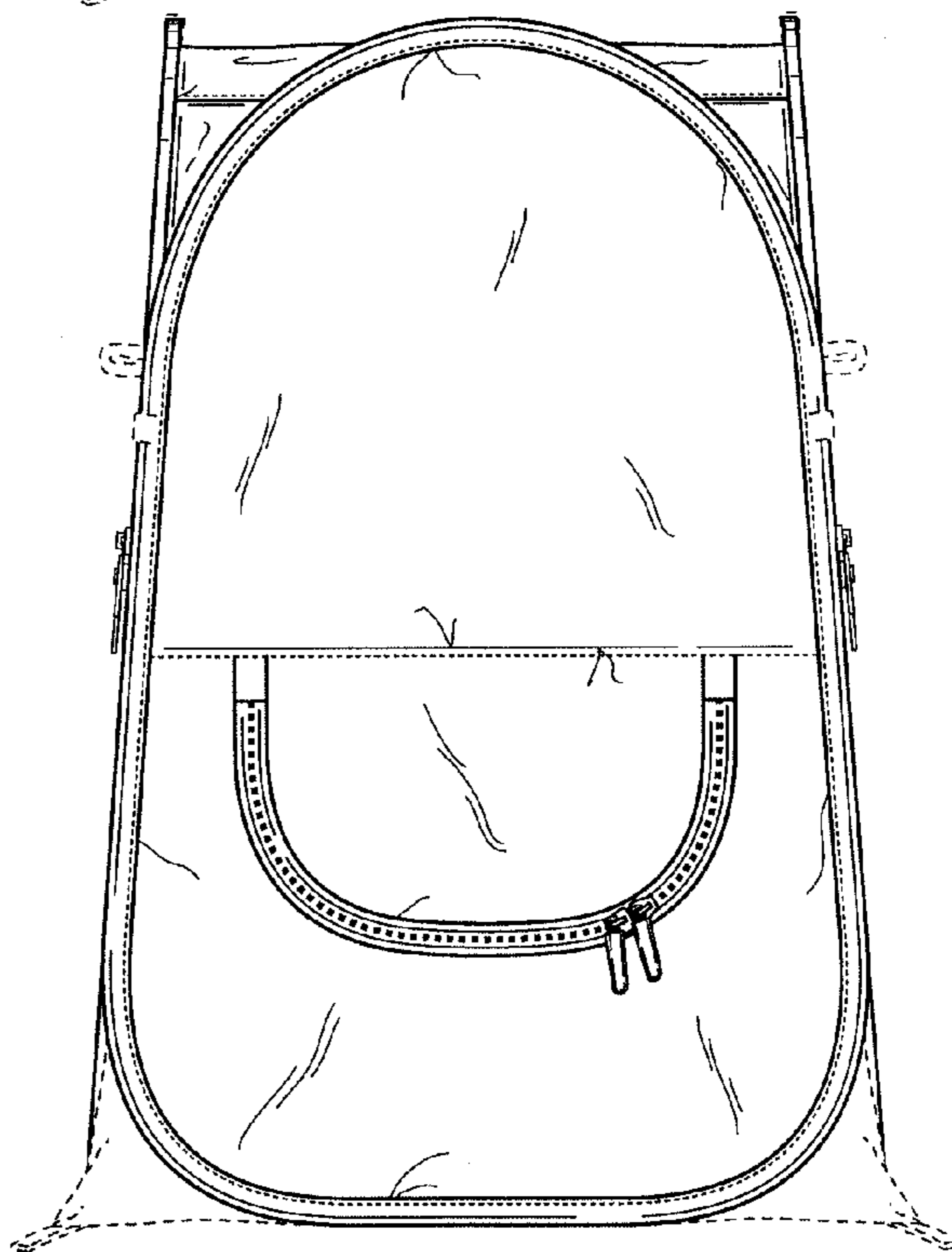

FIG. 3

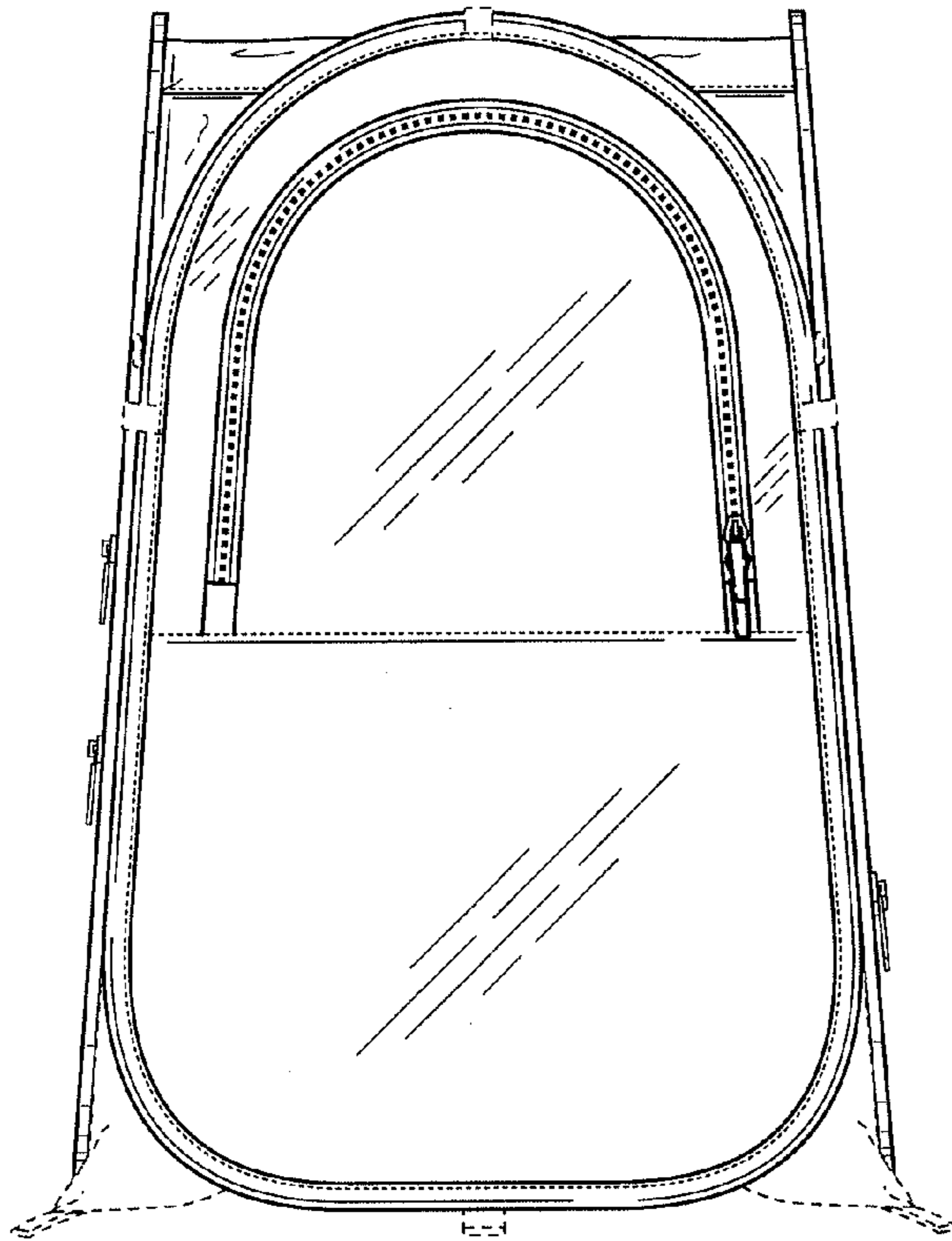

FIG. 4

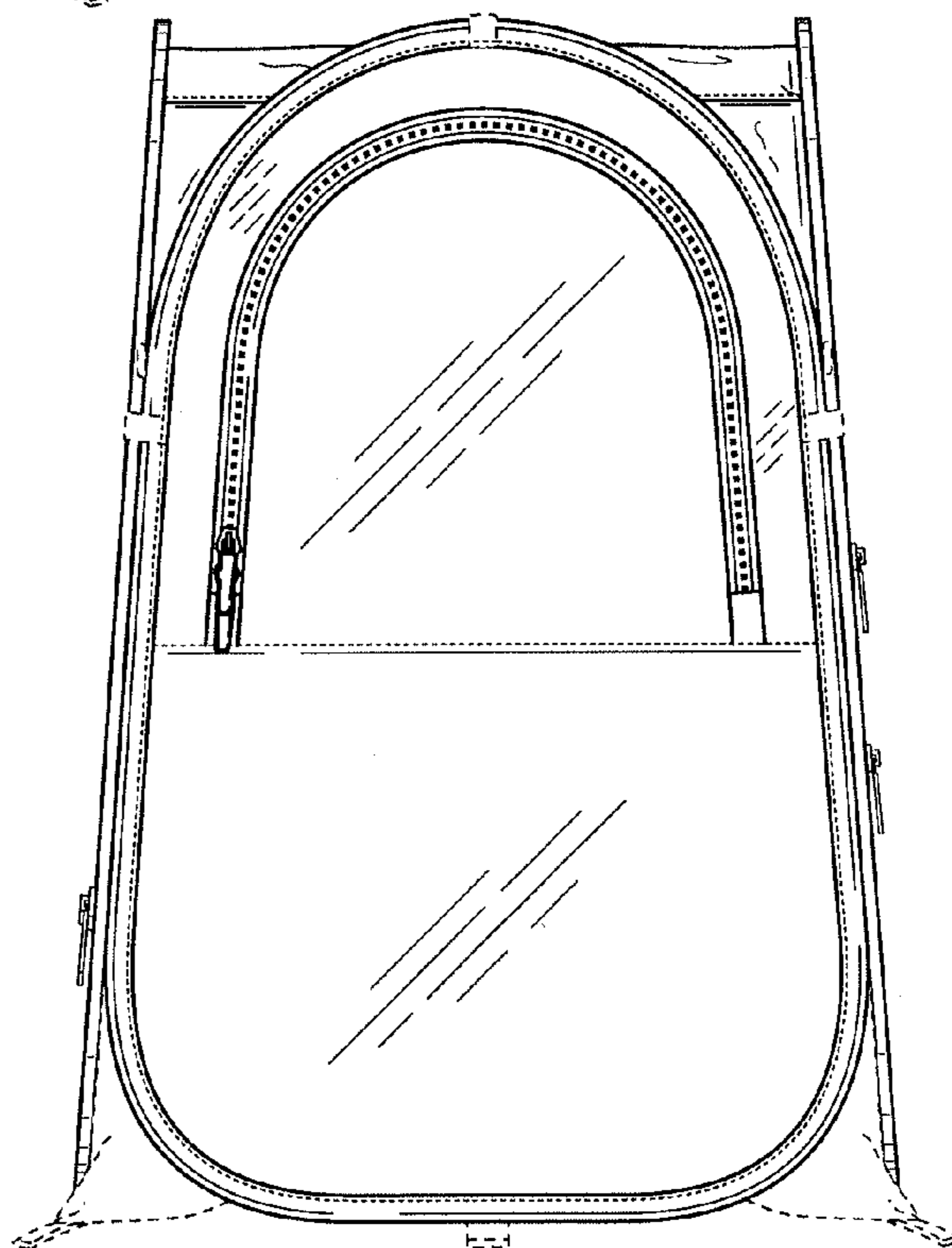

FIG. 5

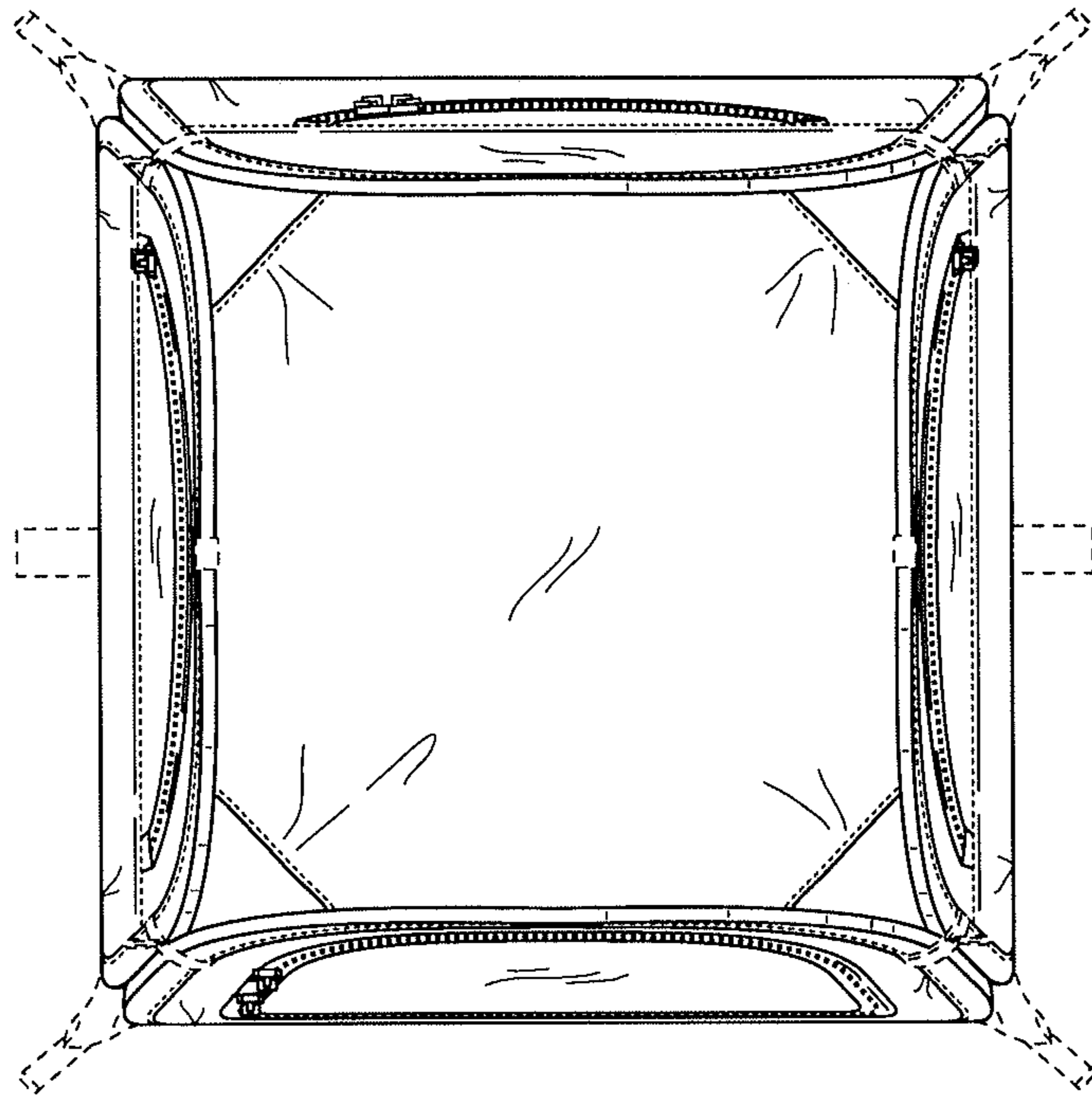

FIG. 6

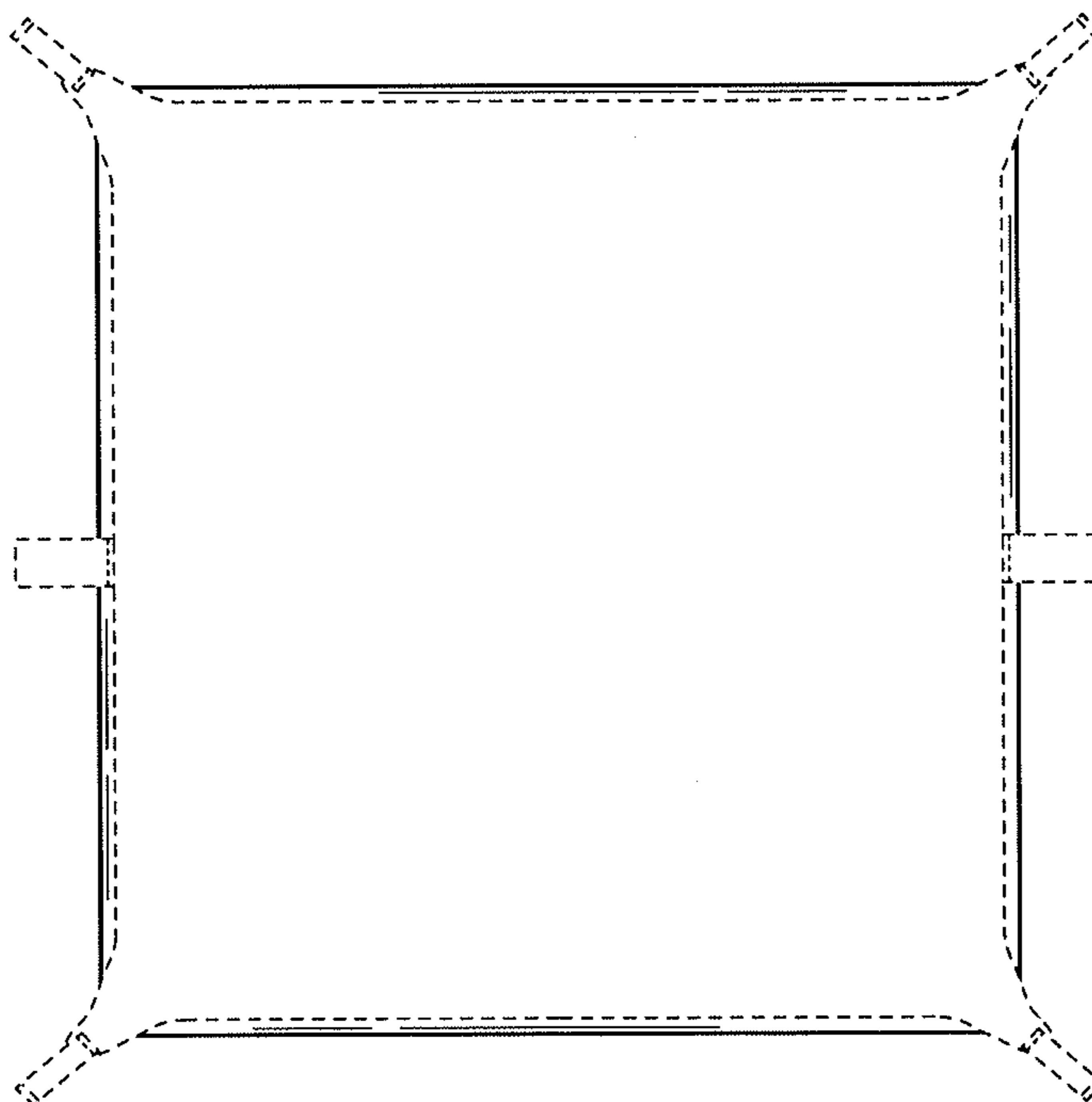

FIG. 7