



US00D772209S

(12) **United States Design Patent** (10) **Patent No.:** **US D772,209 S**  
**Kim et al.** (45) **Date of Patent:** **\*\* Nov. 22, 2016**

(54) **CASE FOR ELECTRONIC DEVICE**

(71) Applicants: **Dae-Young Kim**, Seoul (KR); **Young Kwang Hyun**, Seoul (KR)

(72) Inventors: **Dae-Young Kim**, Seoul (KR); **Young Kwang Hyun**, Seoul (KR)

(73) Assignee: **SPIGEN KOREA CO., LTD.**, Geumcheon-Gu, Seoul (KR)

(\*\*) Term: **14 Years**

(21) Appl. No.: **29/494,067**

(22) Filed: **Jun. 17, 2014**

(51) **LOC (10) Cl.** ..... **14-03**

(52) **U.S. Cl.**  
USPC ..... **D14/250**

(58) **Field of Classification Search**  
USPC ..... D14/250–253, 440, 203.3–203.7, 217, D14/496, 248, 238.1, 240, 447, 230, 247, D14/341, 345, 346, 439; D3/201, 218, 269, D3/301, 273, 303; D13/103, 107–108; 220/4.02; 248/309.1; 361/679.56; 379/426, 433.11, 455; 455/575.1, 455/575.8; 190/100; 206/305, 320  
CPC ..... A45C 2011/002; A45C 11/00; A45C 13/002; A45C 2011/003; H04M 1/0283; H04M 1/0202; H04M 1/185; H04B 1/3888  
See application file for complete search history.

(56) **References Cited**

**U.S. PATENT DOCUMENTS**

D625,303 S \* 10/2010 Kim ..... D14/250  
D657,782 S \* 4/2012 Biller ..... D14/250  
8,439,191 B1 \* 5/2013 Lu ..... H04B 1/3888  
206/320  
D689,852 S \* 9/2013 Azoulay ..... D14/250  
D703,655 S \* 4/2014 Melanson ..... D14/250  
D712,386 S \* 9/2014 Lu ..... D14/250  
D714,274 S \* 9/2014 Jung ..... D14/250  
D721,067 S \* 1/2015 Su ..... D14/250

9,071,674 B2 \* 6/2015 Yow ..... H04M 1/0283  
D736,205 S \* 8/2015 Park ..... D14/138 R  
9,143,181 B1 \* 9/2015 Jia ..... H04B 1/3888  
D741,279 S \* 10/2015 Tai ..... D14/138 G  
2009/0283184 A1 \* 11/2009 Han ..... H04B 1/3888  
150/165

**OTHER PUBLICATIONS**

Spigen Slim Armor Cover Case for iPhone 6, “http://www.amazon.co.uk/Spigen-Slim-Armor-Cover-iPhone/dp/B00JH88F12/ref=sr\_1\_10?ie=UTF8&qid=1447215871&sr=8-10 &keywords=spigen+armor+slim+iphone+6”, Jul. 18, 2014 (retrieved Nov. 10, 2015).\*

(Continued)

*Primary Examiner* — Sandra Snapp

*Assistant Examiner* — Holly E Thurman

(74) *Attorney, Agent, or Firm* — East West Law Group; Heedong Chae

(57) **CLAIM**

The ornamental design for a case for electronic device, as shown and described.

**DESCRIPTION**

FIG. 1 is a front perspective view of a case for electronic device, comprised of inner portion and outer portion, showing my new design;  
FIG. 2 is a rear perspective view thereof;  
FIG. 3 is a front elevational view thereof;  
FIG. 4 is a rear elevational view thereof;  
FIG. 5 is a left side elevational view thereof;  
FIG. 6 is a right side elevational view thereof;  
FIG. 7 is a top plan view thereof;  
FIG. 8 is a bottom plan view thereof; and,  
FIG. 9 is an exploded front perspective view thereof showing the inner and outer portions of the case for electronic device separated for clarity of disclosure.  
The broken lines depict of unclaimed environment and form no part of the claimed design.

**1 Claim, 9 Drawing Sheets**

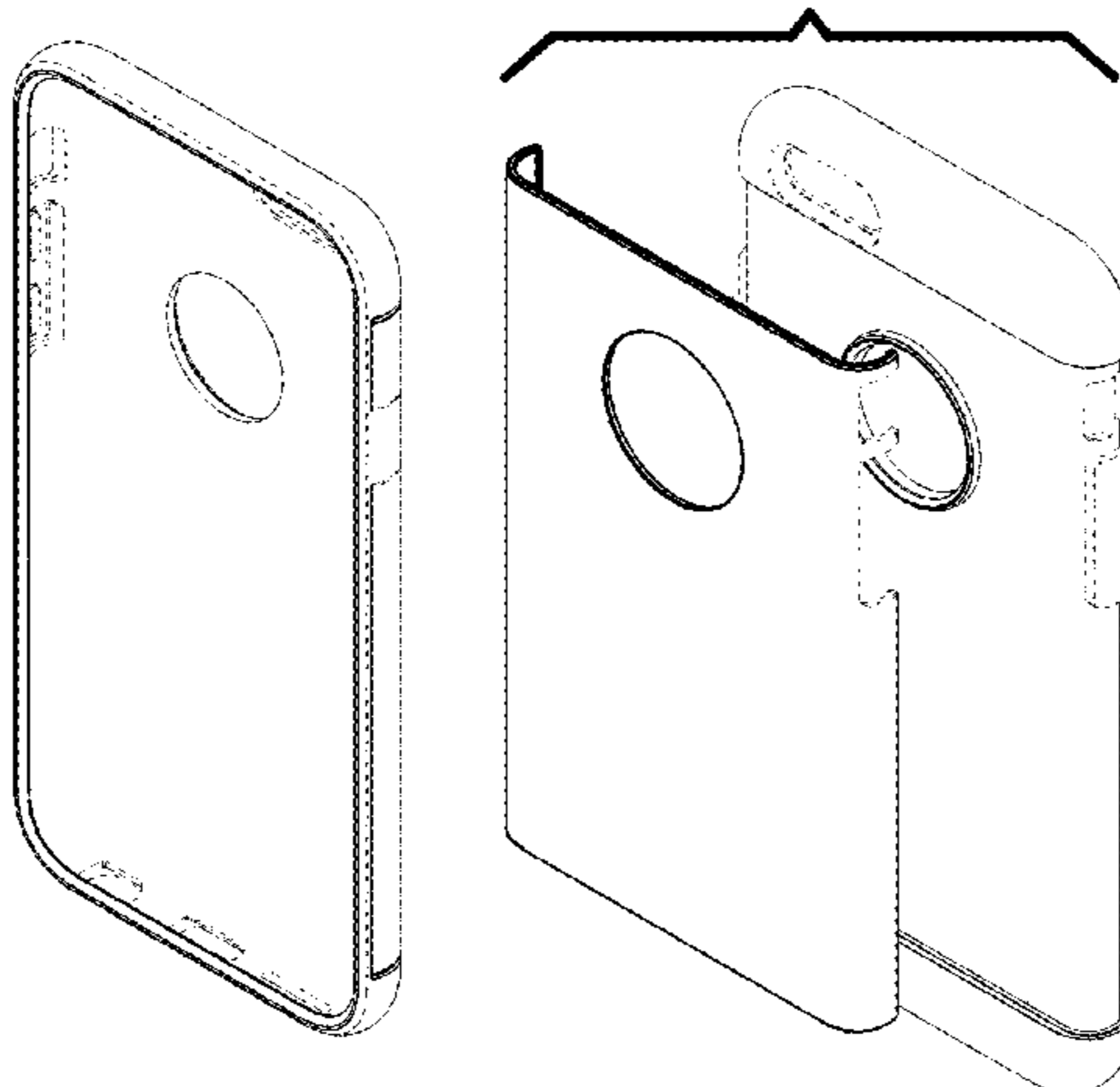

(56)

**References Cited**

OTHER PUBLICATIONS

“iPhone SE/5s/5/TONE,”<https://www.switcheasy.com/iphone-se5s5/24-tones>, Downloaded Jun. 3, 2016, 4 Page.

“iPhone 5S/5 Case Slim Armor,” <http://www.spigen.com/products/iphone-5s-5-case-slim-armor-s?variant=1162051877>, Downloaded Jun. 3, 2016. 4 Pages.

\* cited by examiner

FIG. 1

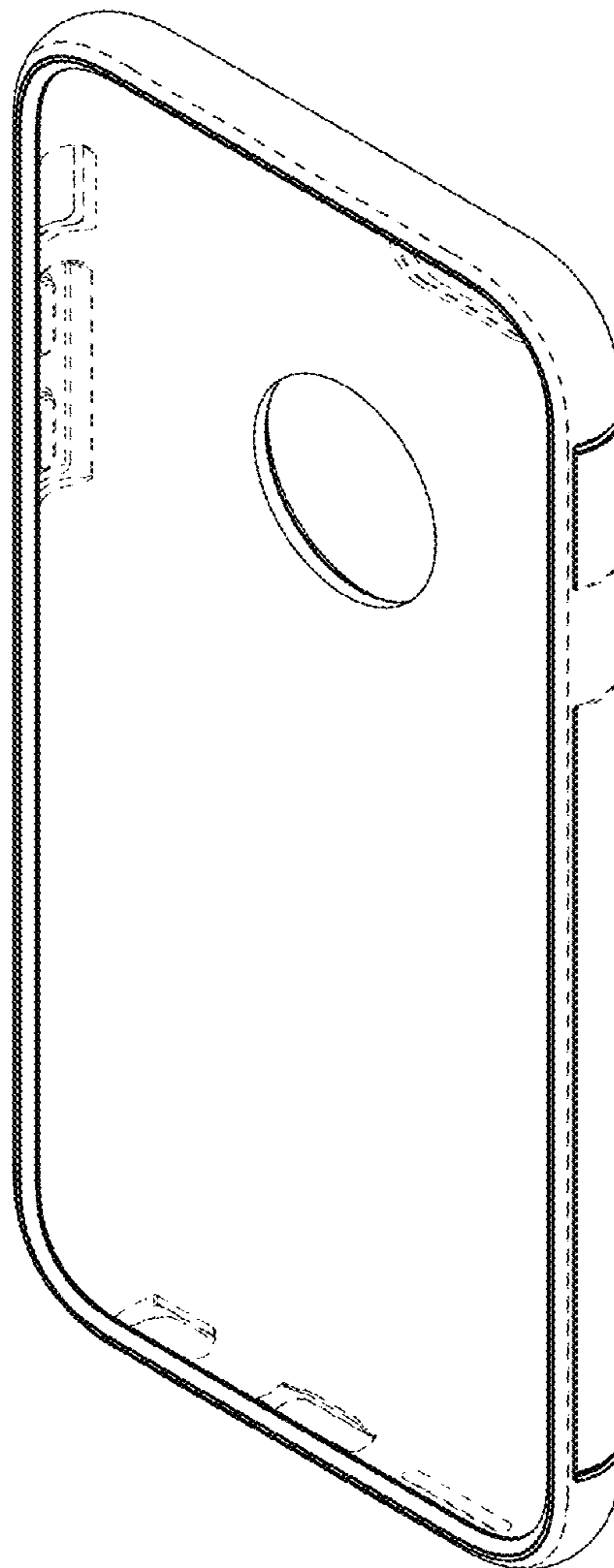

FIG. 2

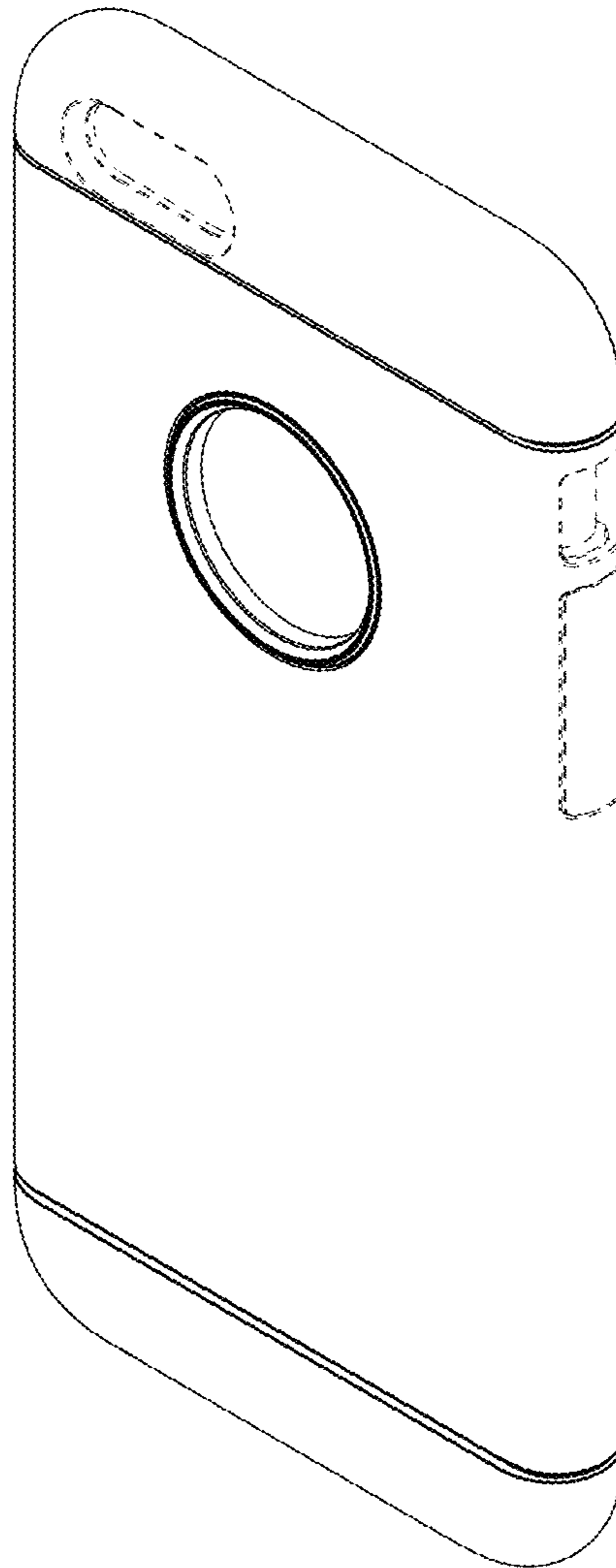

FIG. 3

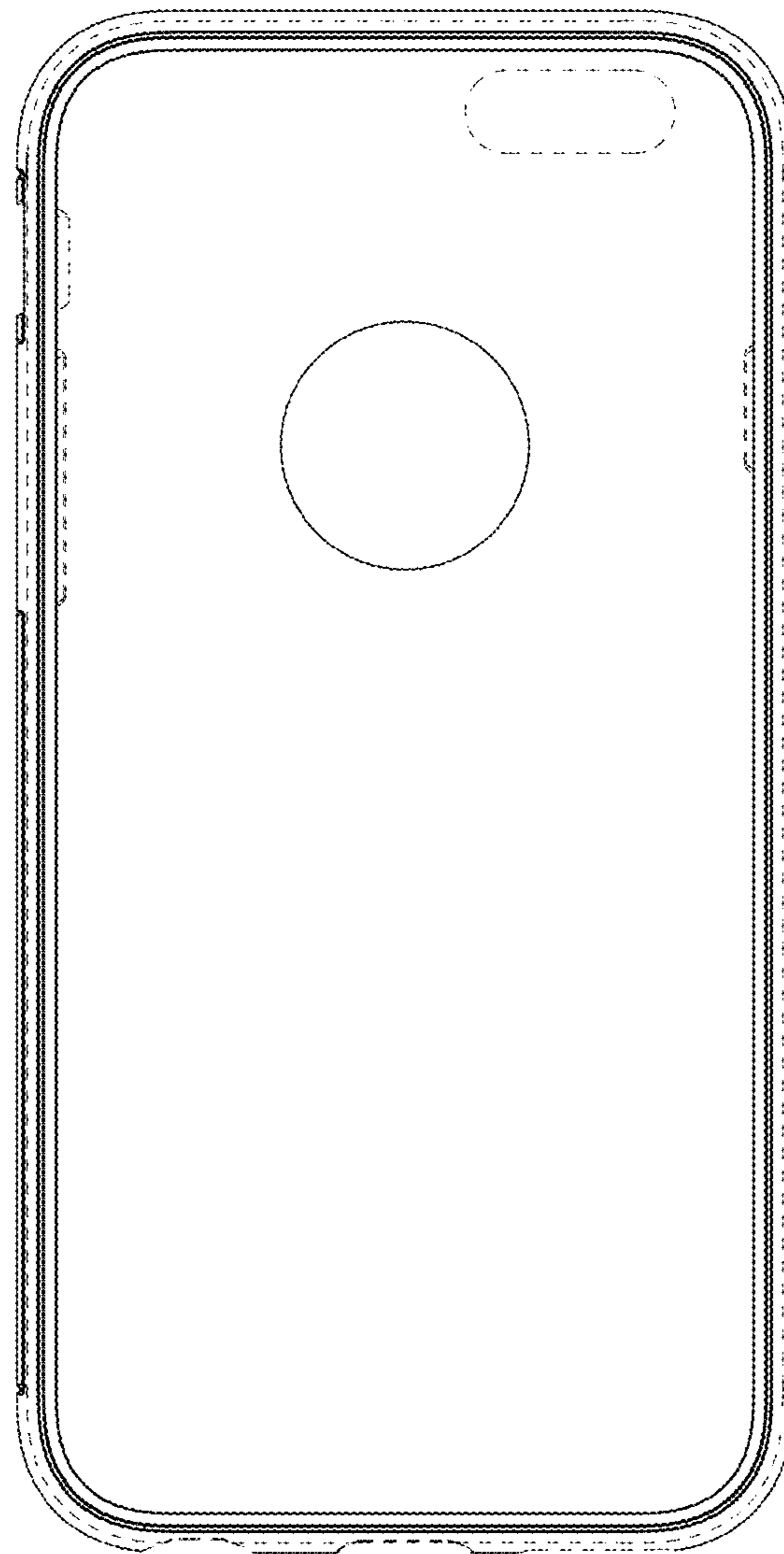

FIG. 4

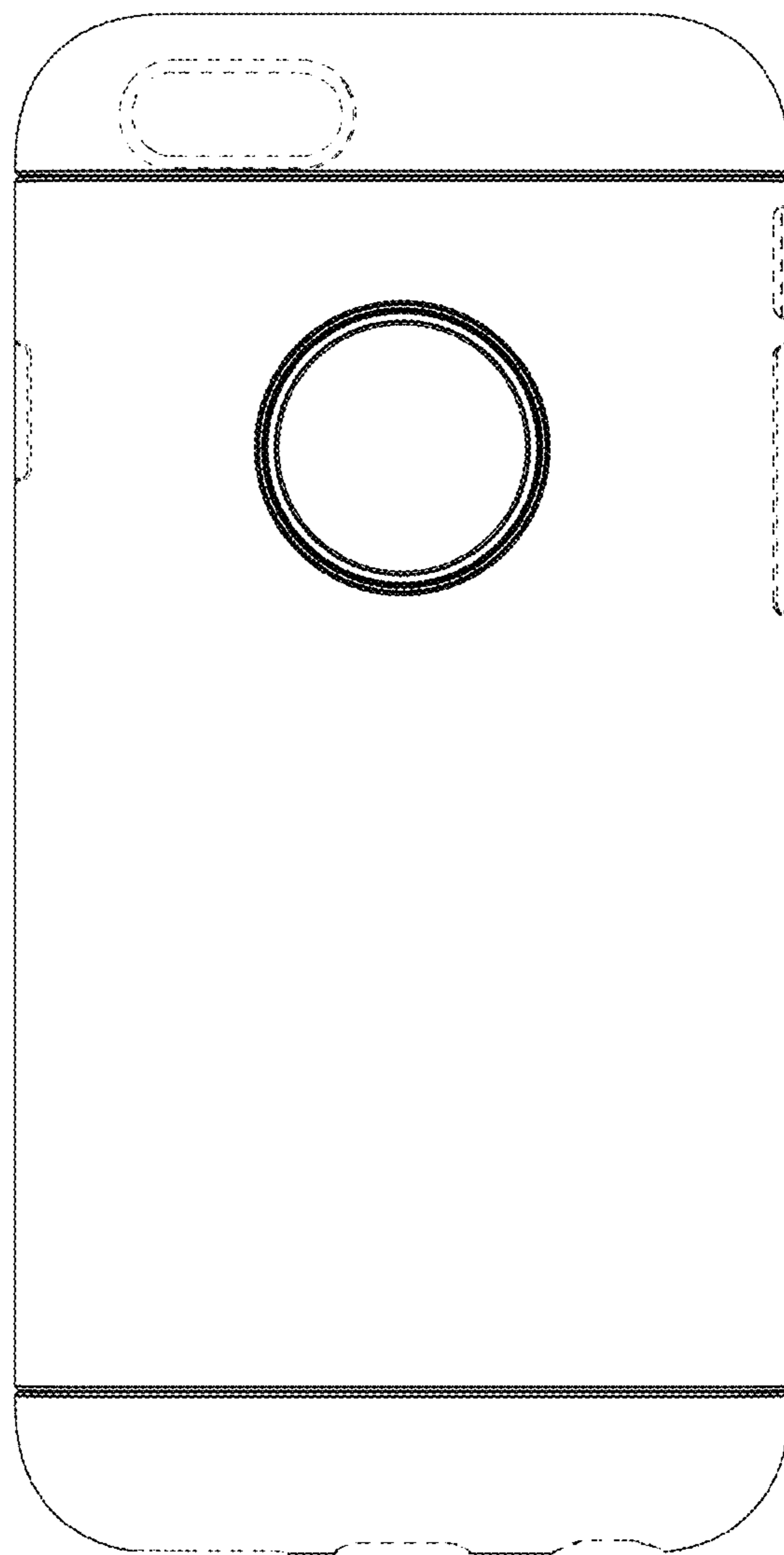

FIG. 5



FIG. 6

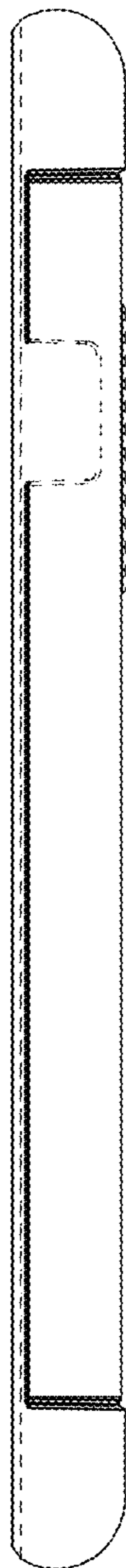



FIG. 7



FIG. 8

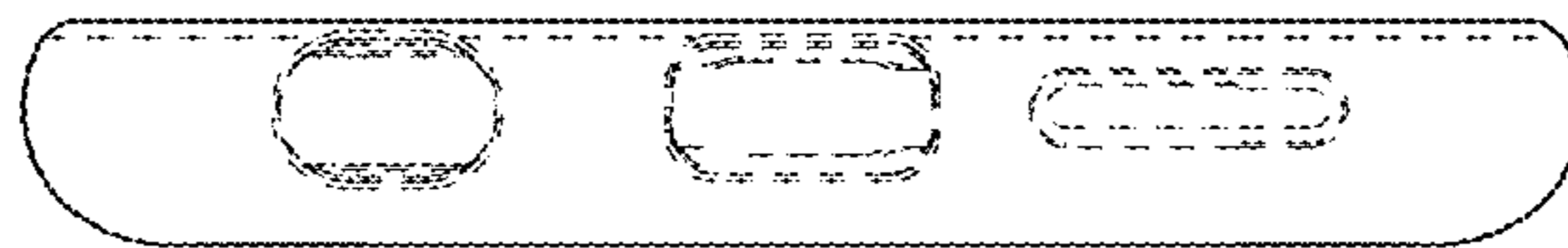

FIG. 9

