



US00D552665S

(12) **United States Design Patent**
Mage

(10) **Patent No.:** **US D552,665 S**

(45) **Date of Patent:** **** Oct. 9, 2007**

(54) **SUNGLASS**

(75) **Inventor:** **Jerome J. M. Mage**, Beverly Hills, CA (US)

(73) **Assignee:** **Spy Optic, Inc.**, Carlsbad, CA (US)

(**) **Term:** **14 Years**

(21) **Appl. No.:** **29/267,933**

(22) **Filed:** **Oct. 25, 2006**

(51) **LOC (8) Cl.** **16-06**

(52) **U.S. Cl.** **D16/326**

(58) **Field of Classification Search** D16/101,
D16/300-330, 332-338, 900; D21/190;
D24/110.2; 351/41, 44, 51, 52, 61-63, 83,
351/86, 92, 103-111, 114, 117, 119, 121-124,
351/128, 130-132, 136-139, 153, 158; 2/426-432,
2/434-437, 441, 447-449, 453; D29/109;
359/358

See application file for complete search history.

(56) **References Cited**

U.S. PATENT DOCUMENTS

5,828,436	A *	10/1998	Lester	351/41
D496,064	S *	9/2004	Mangum	D16/327
D500,781	S *	1/2005	Mage	D16/326
D505,151	S *	5/2005	Windham	D16/326

6,950,531	B2 *	9/2005	Rickards	381/381
D515,617	S *	2/2006	Stables	D16/321
D534,573	S *	1/2007	Mage	D16/326
D534,942	S *	1/2007	Lynch	D16/326
D541,839	S *	5/2007	Sheldon	D16/326
2006/0268218	A1 *	11/2006	Medana	351/41

* cited by examiner

Primary Examiner—T. Chase Nelson

Assistant Examiner—Barbara Blanton Lohr

(74) *Attorney, Agent, or Firm*—Stetina Brunda Garred & Brucker

(57) **CLAIM**

The ornamental design for a sunglass, as shown and described.

DESCRIPTION

FIG. 1 is a front perspective view of the sunglass of the present invention showing my new design;

FIG. 2 is a front elevational view thereof;

FIG. 3 is a side elevational view thereof;

FIG. 4 is a rear elevational view thereof;

FIG. 5 is a top plan view thereof; and,

FIG. 6 is a bottom plan view thereof.

1 Claim, 2 Drawing Sheets

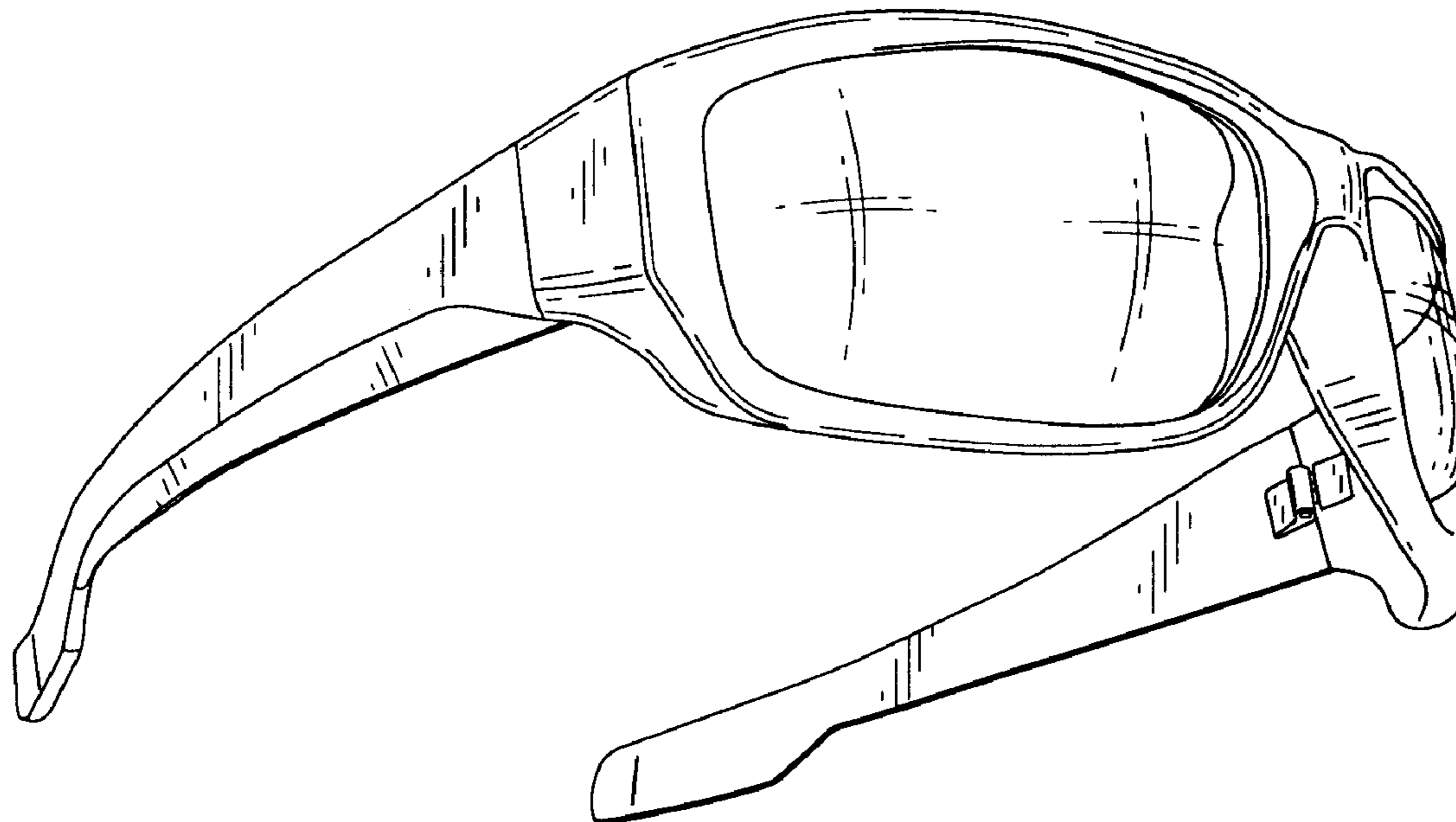

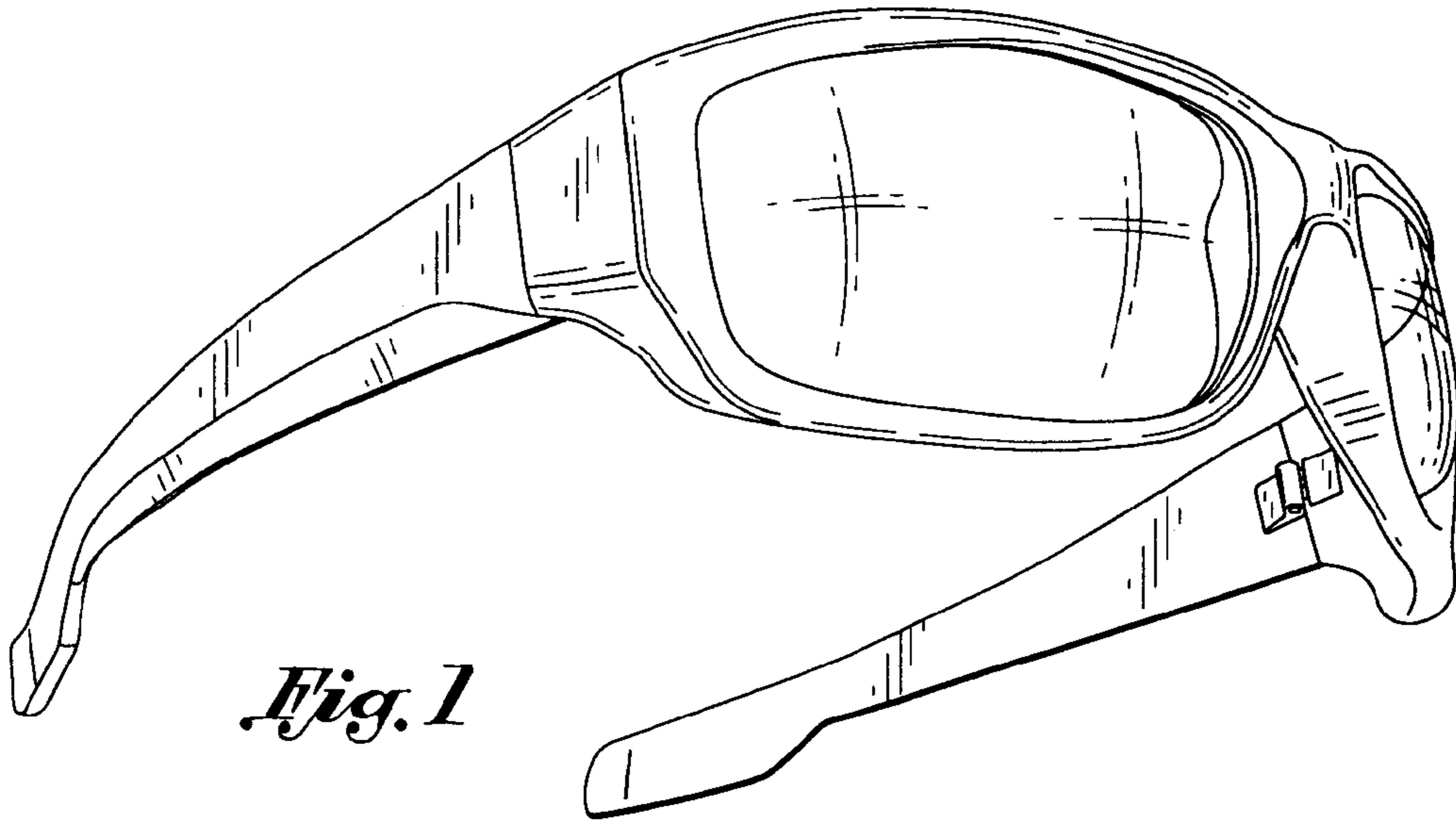

Fig. 1

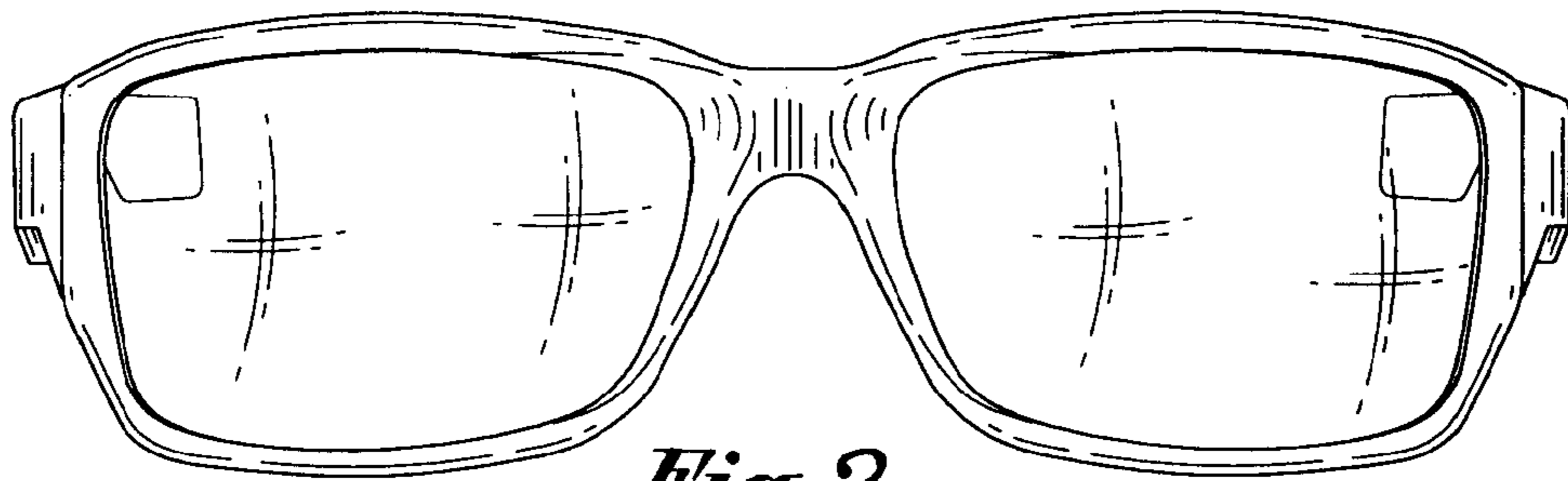

Fig. 2

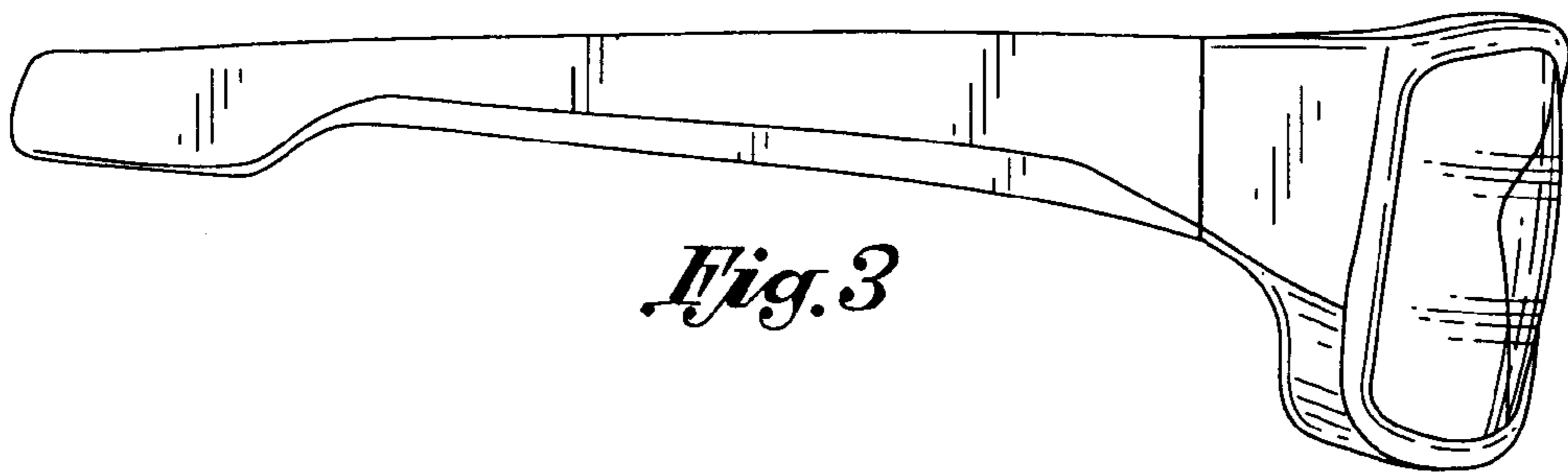

Fig. 3

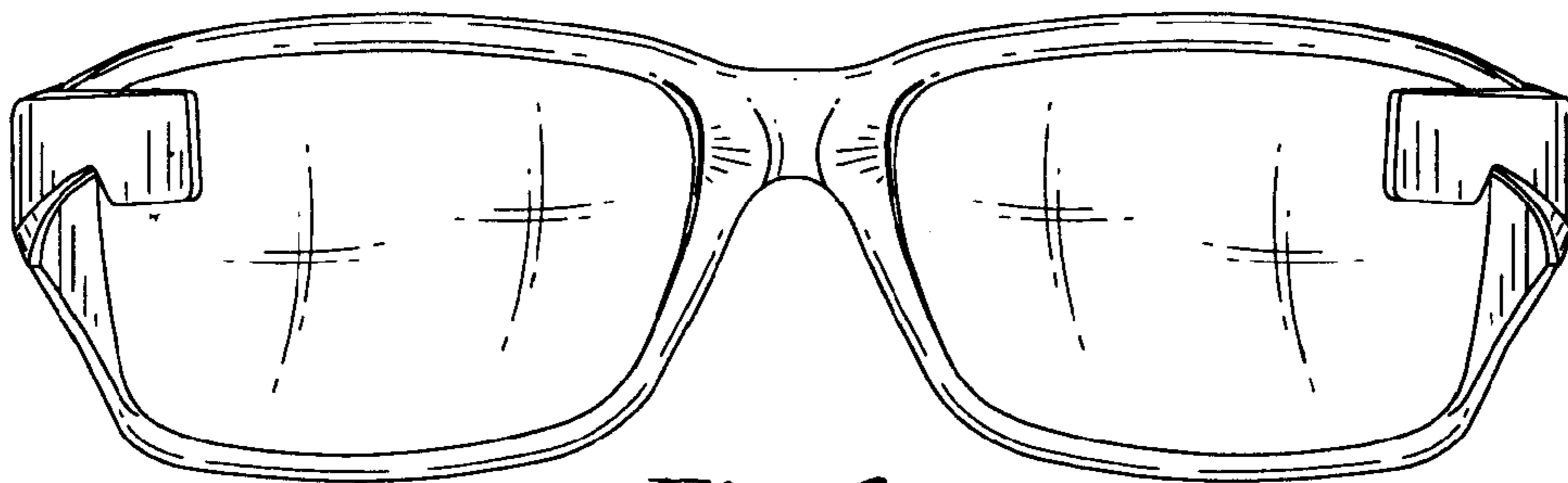

Fig. 4

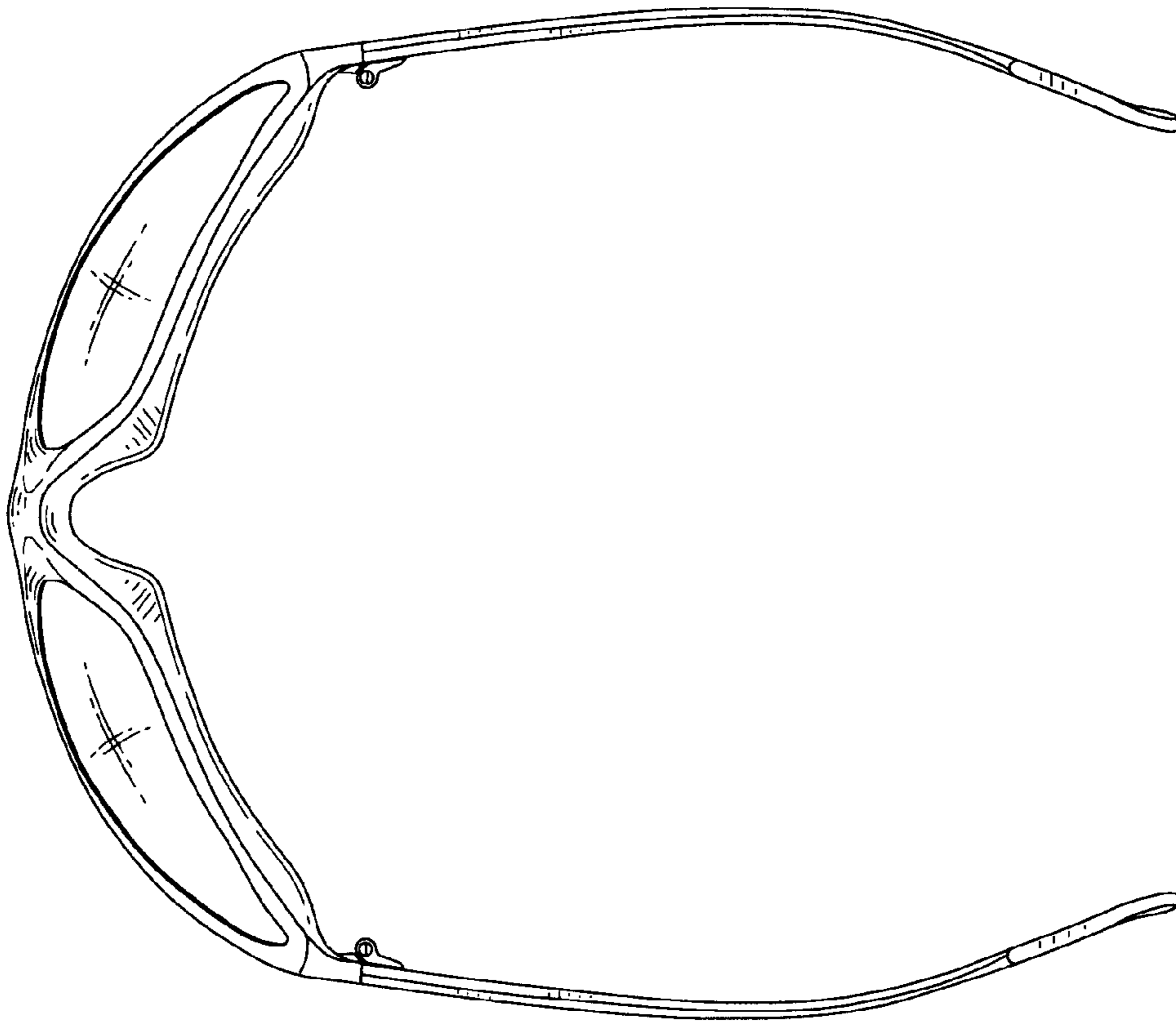

Fig. 6

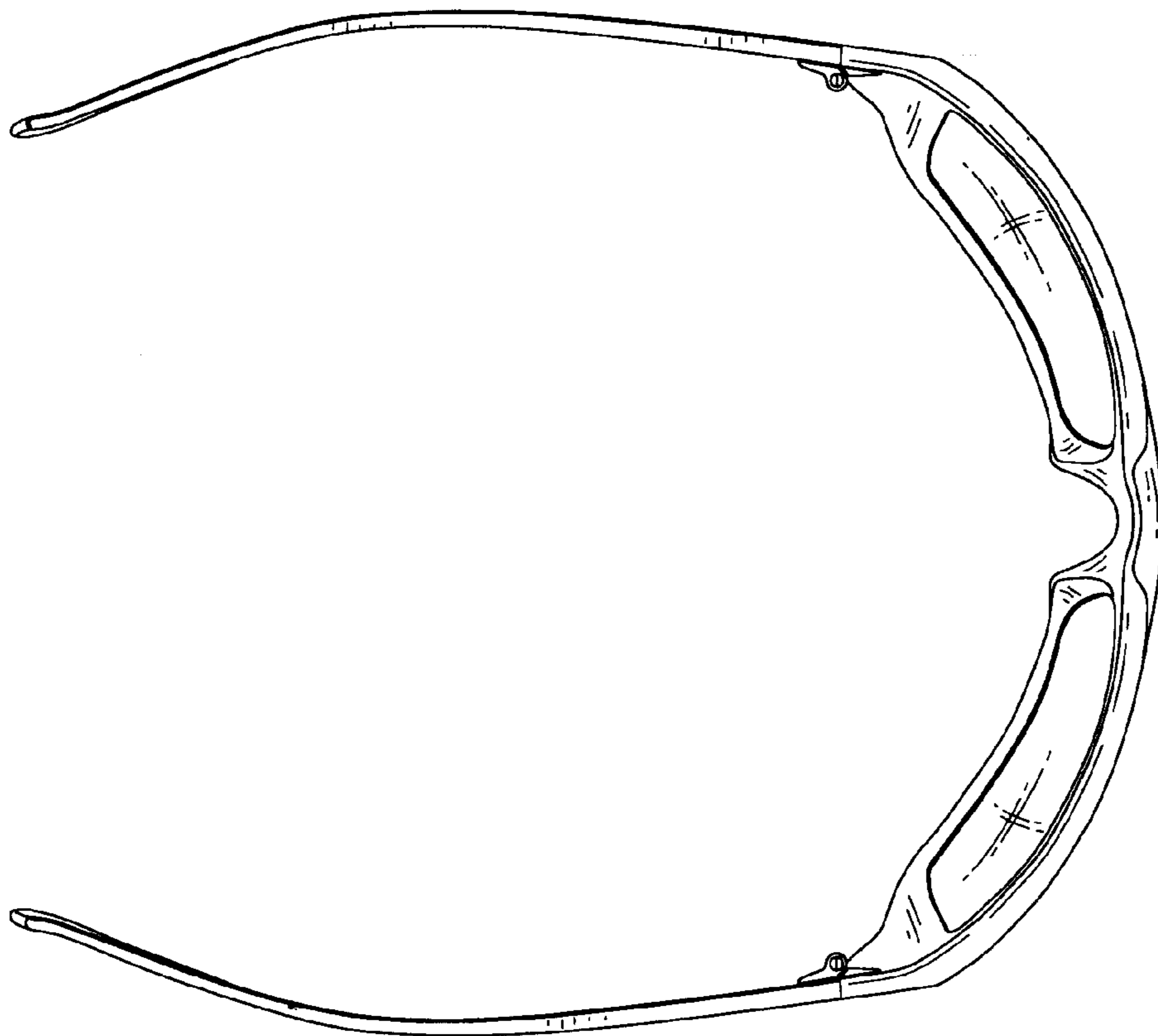

Fig. 5